



Puerta López





GREENPEACE

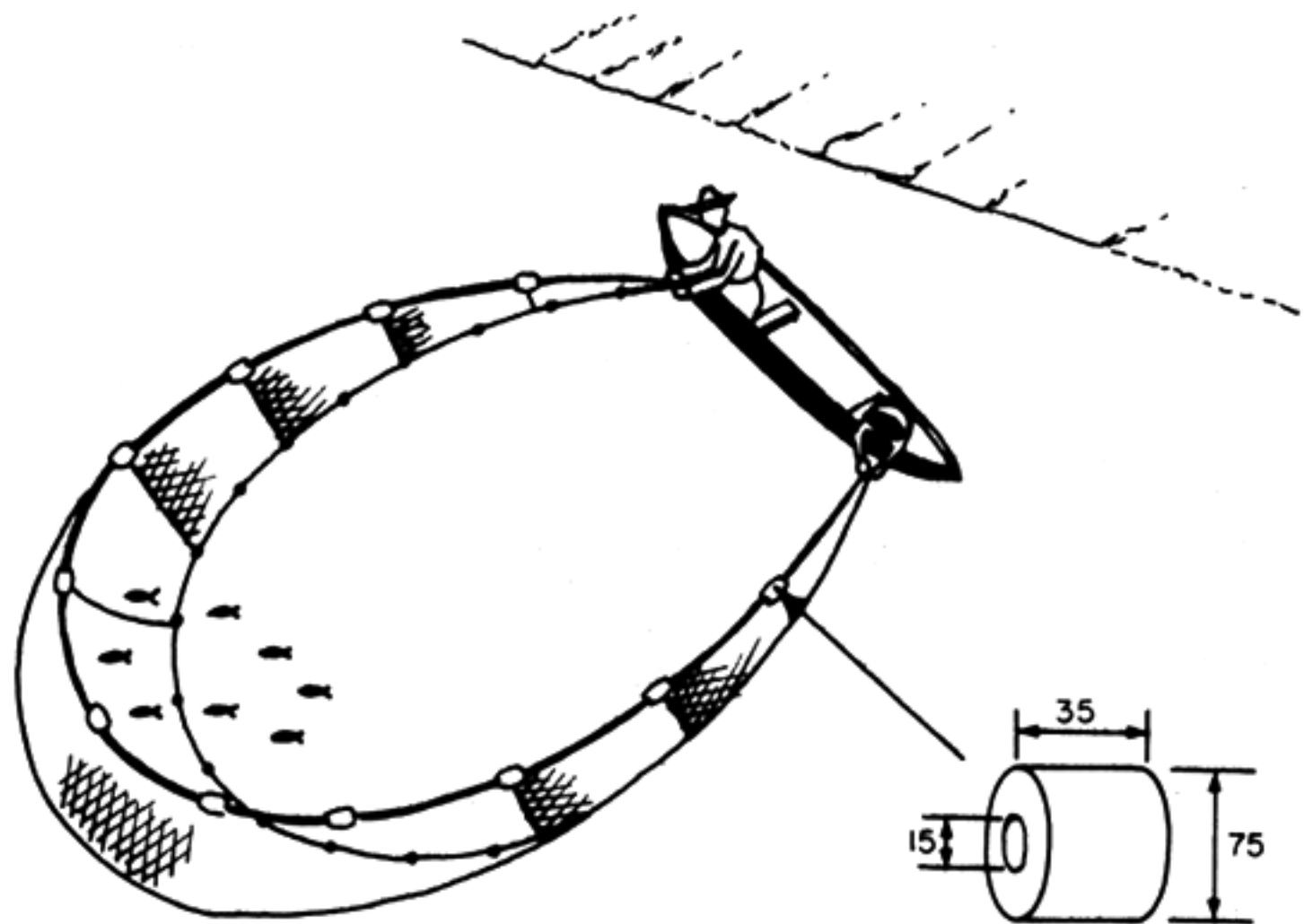

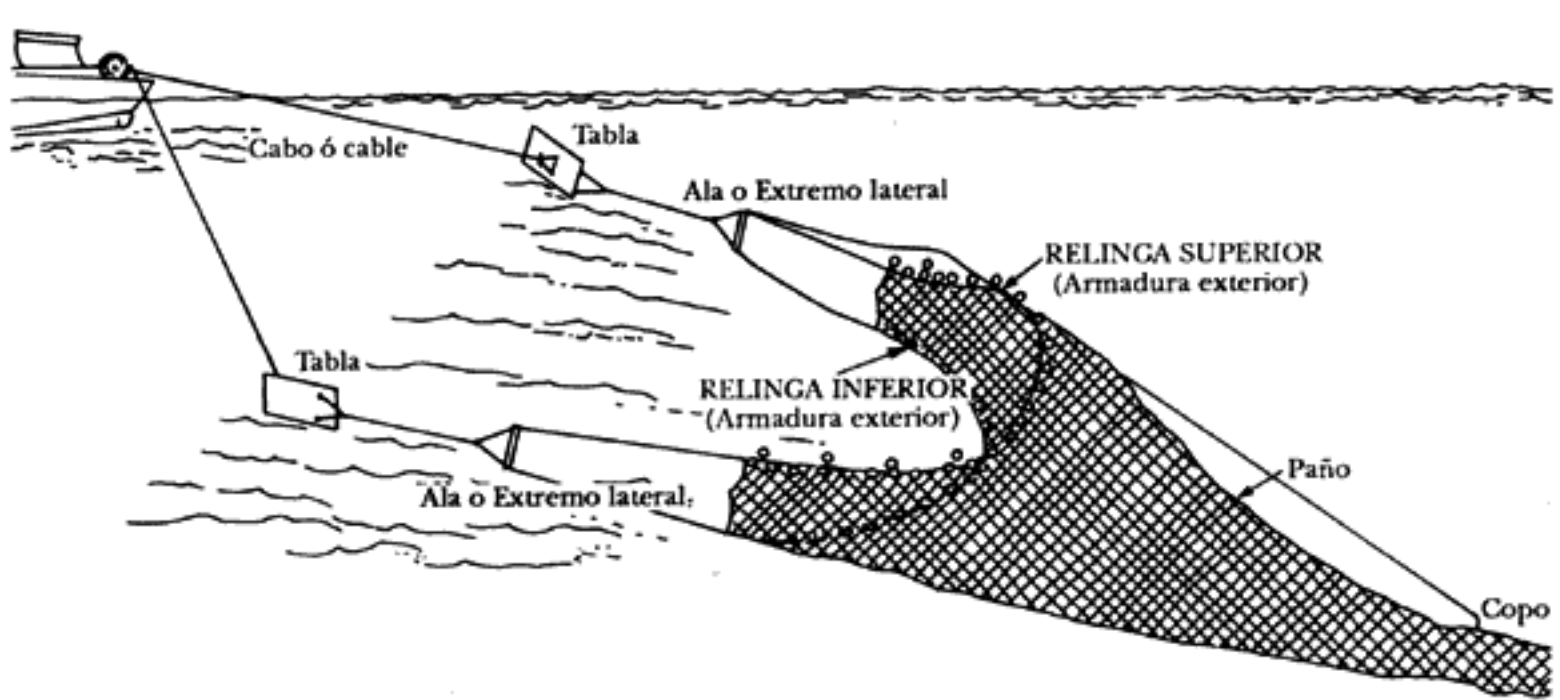

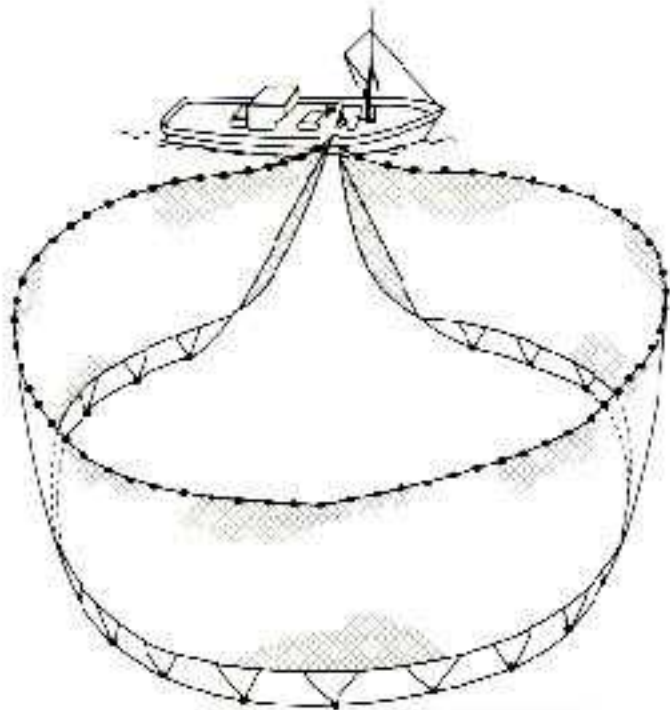

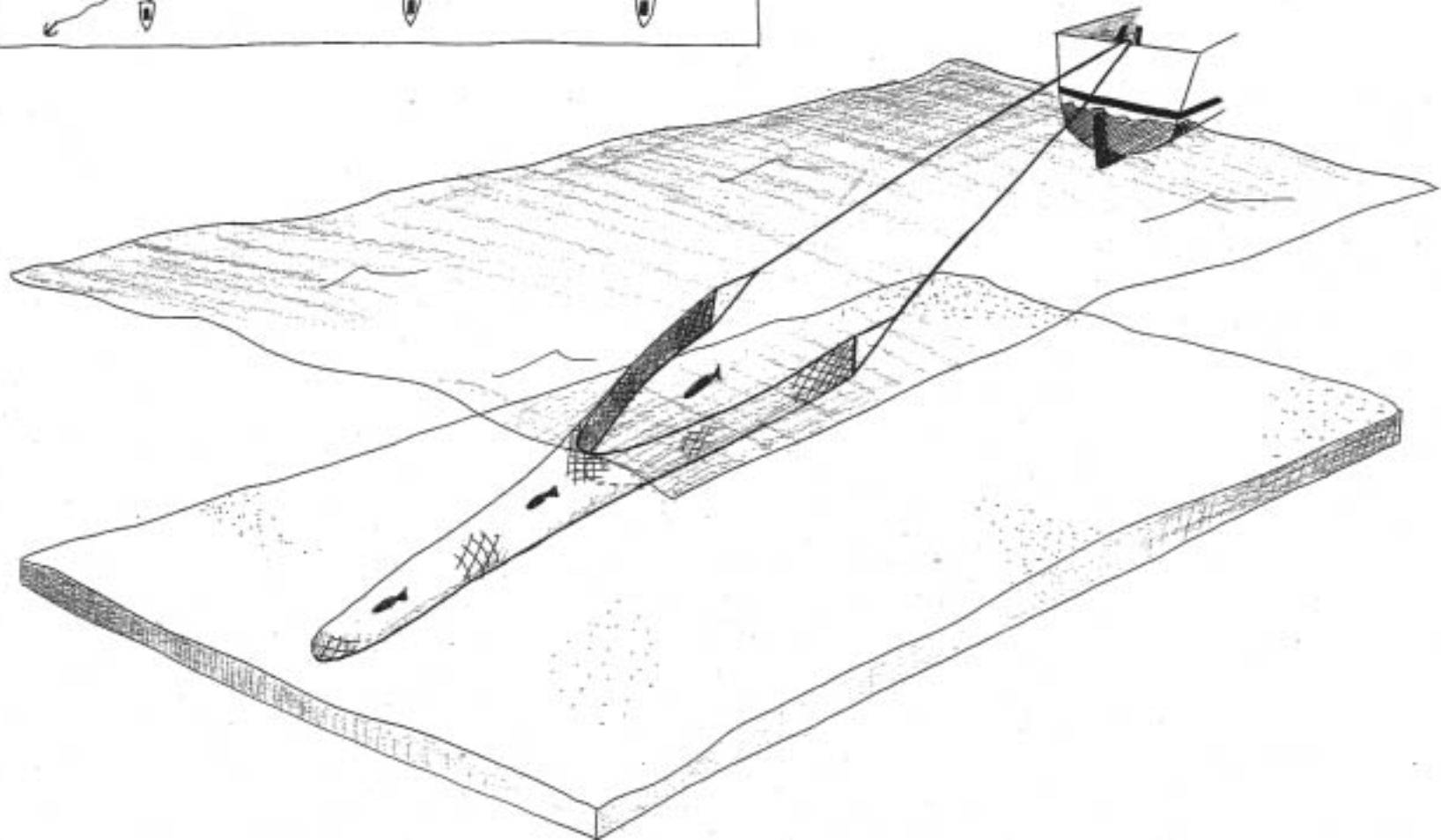
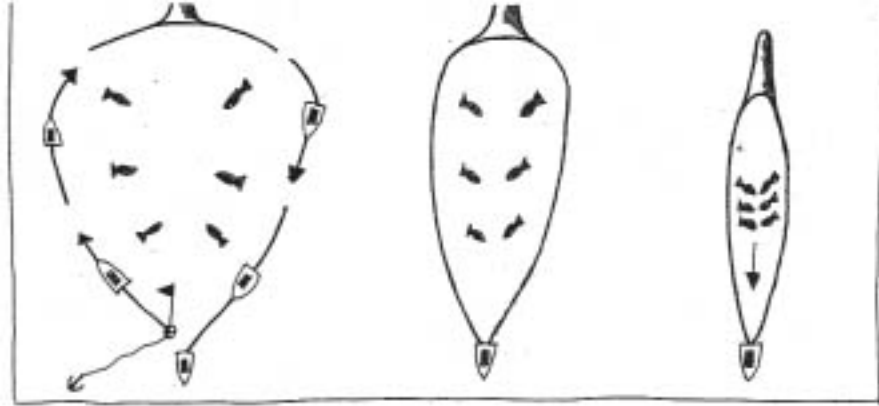

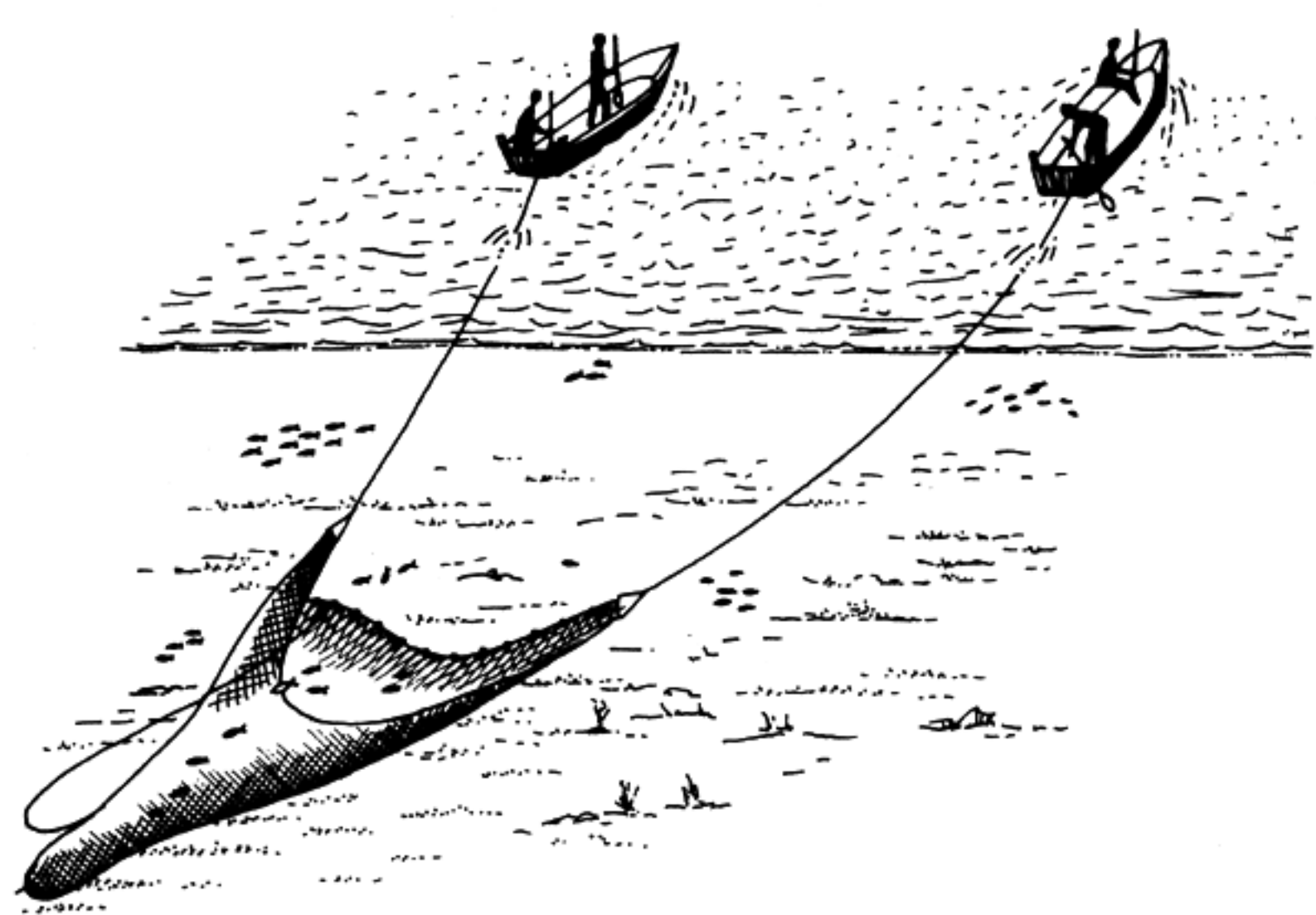

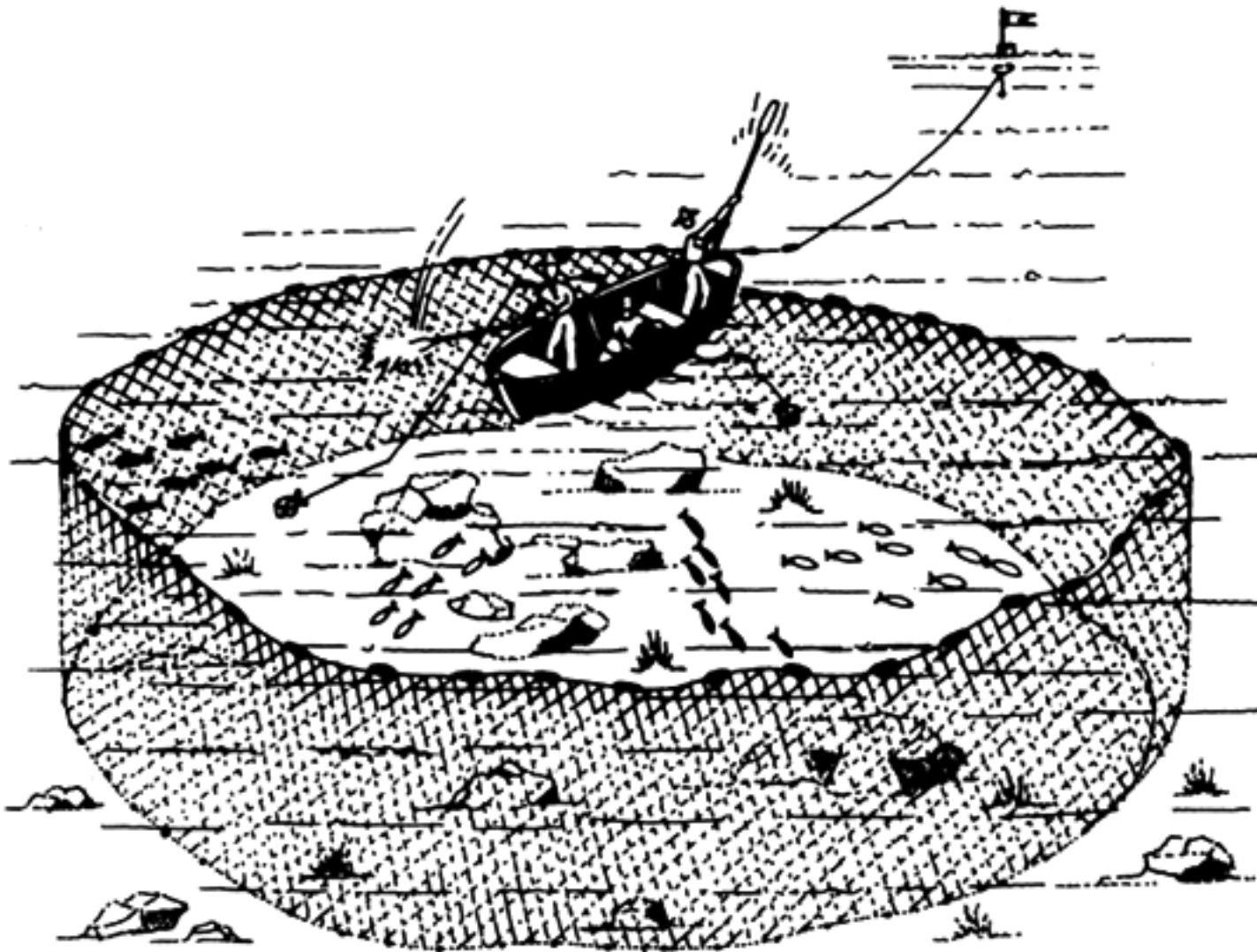



AT4K6R Alamy Images

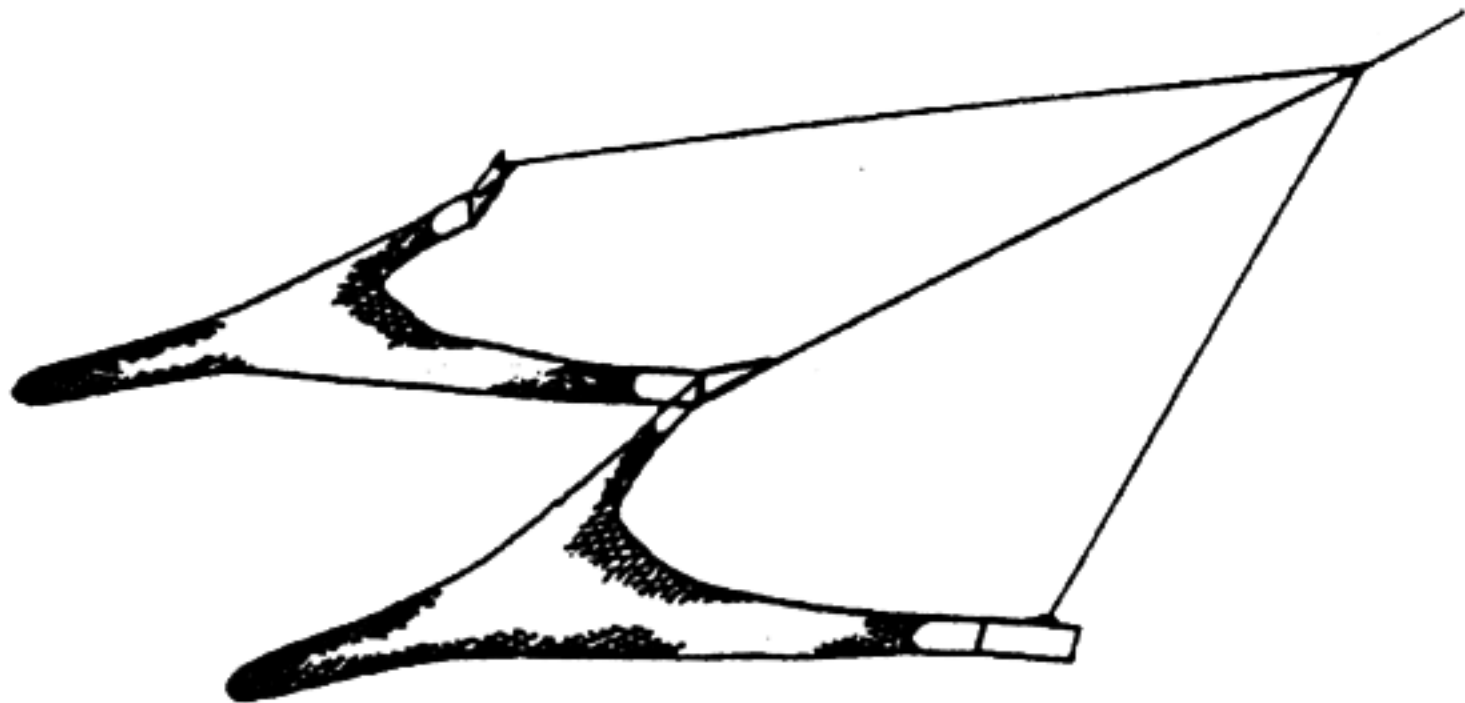

Carnada

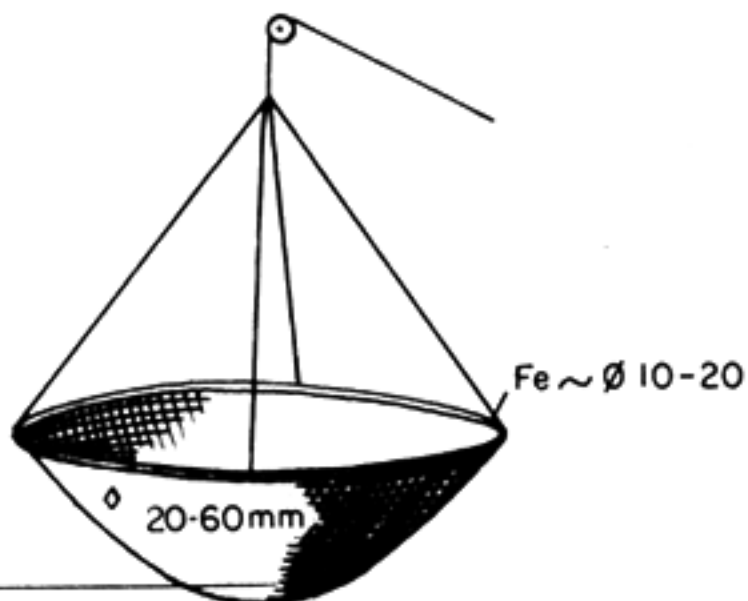
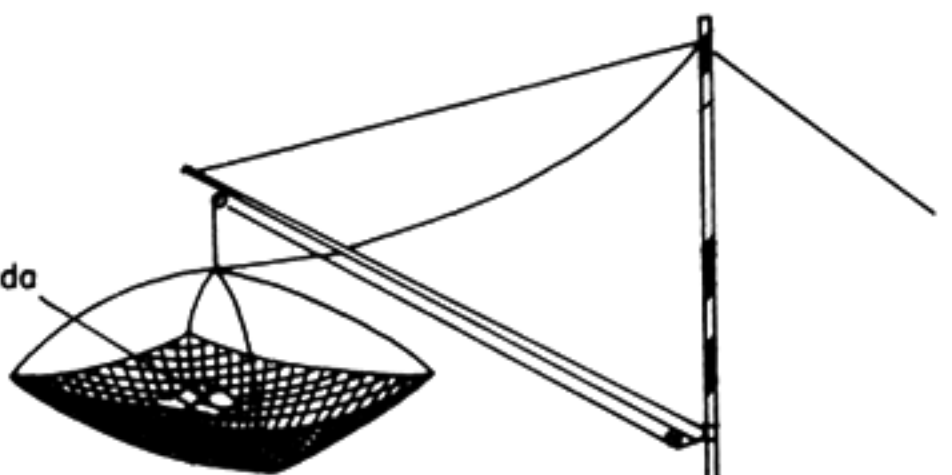

Malla de fino alambre galvanizado
o fibras sintéticas (PA R 1000 tex)

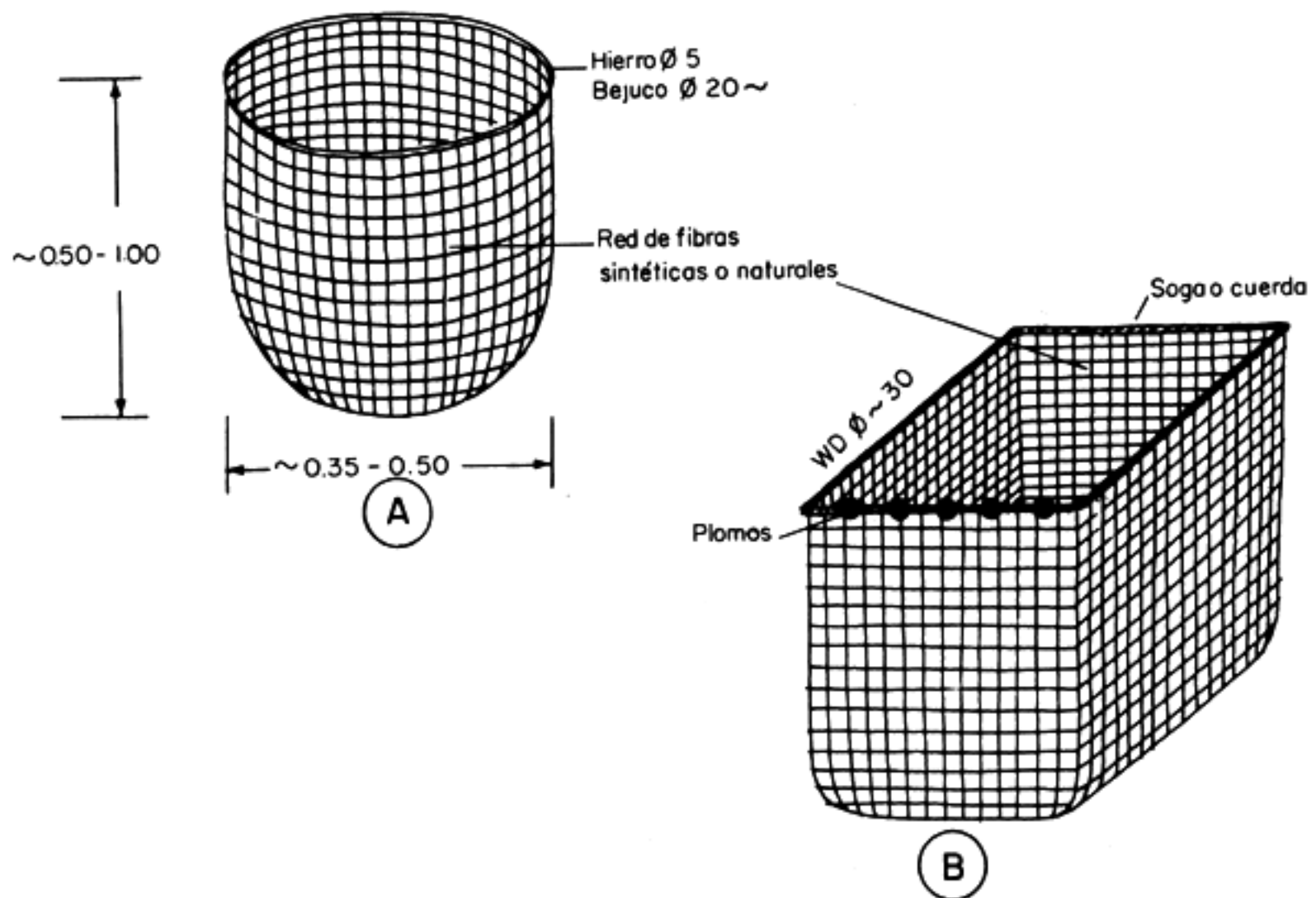

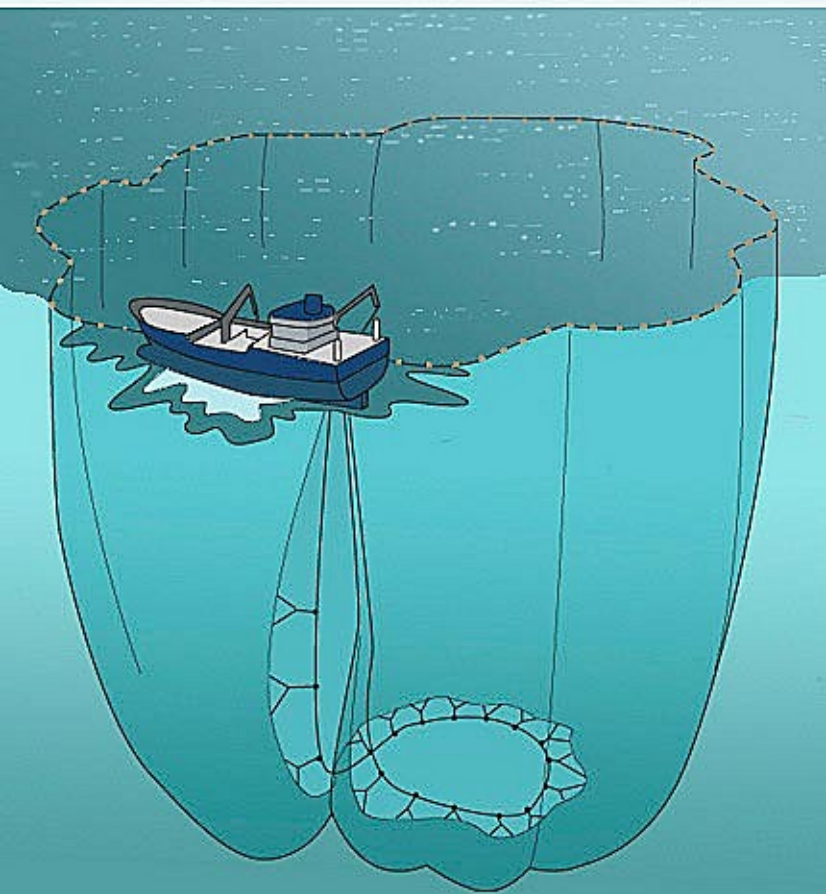

GREENPEACE





SCALLOP DREDGE

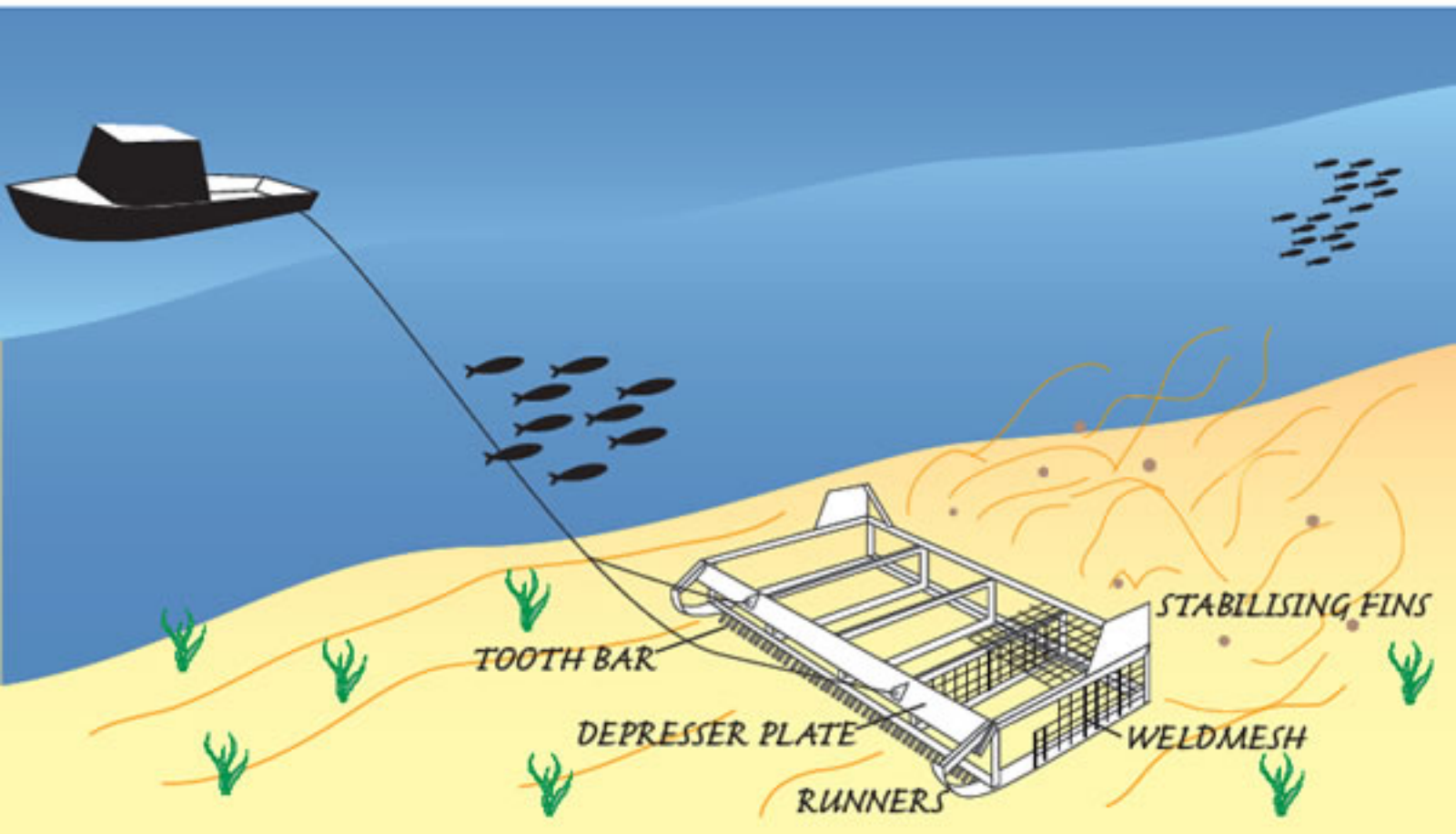

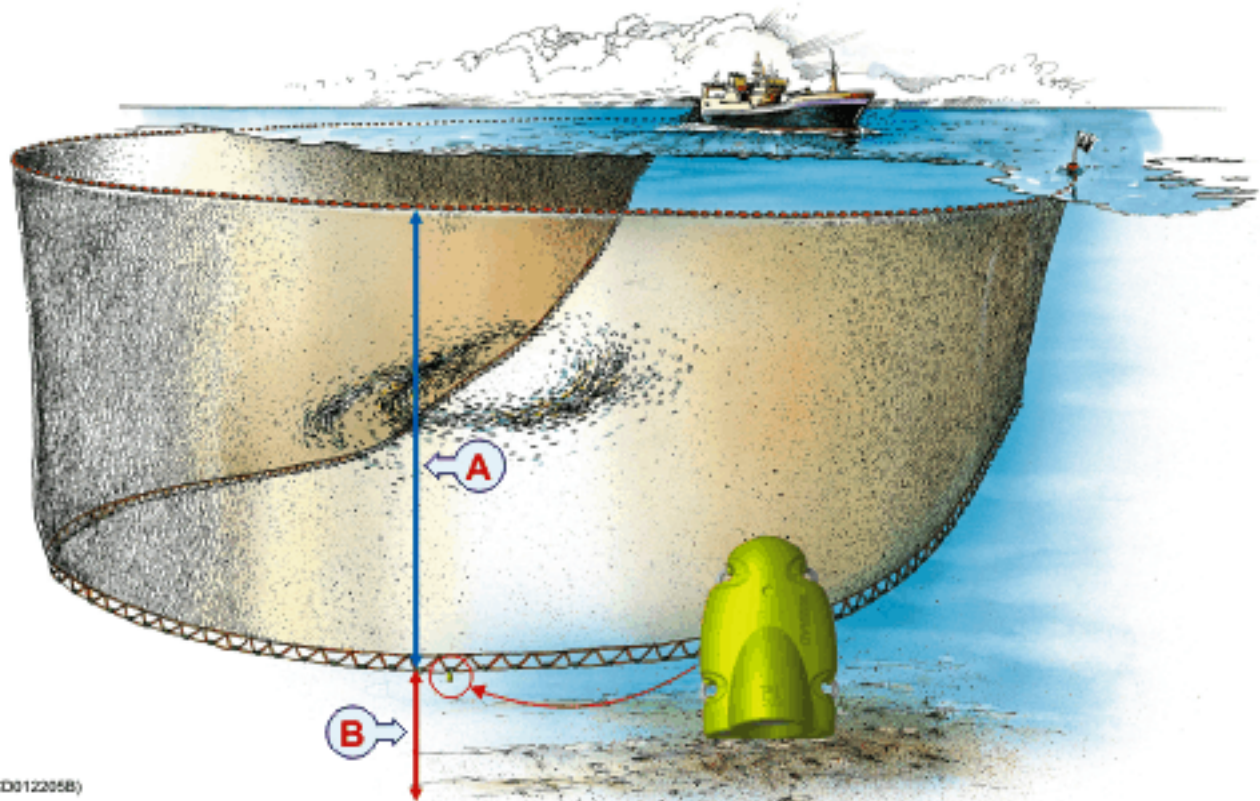

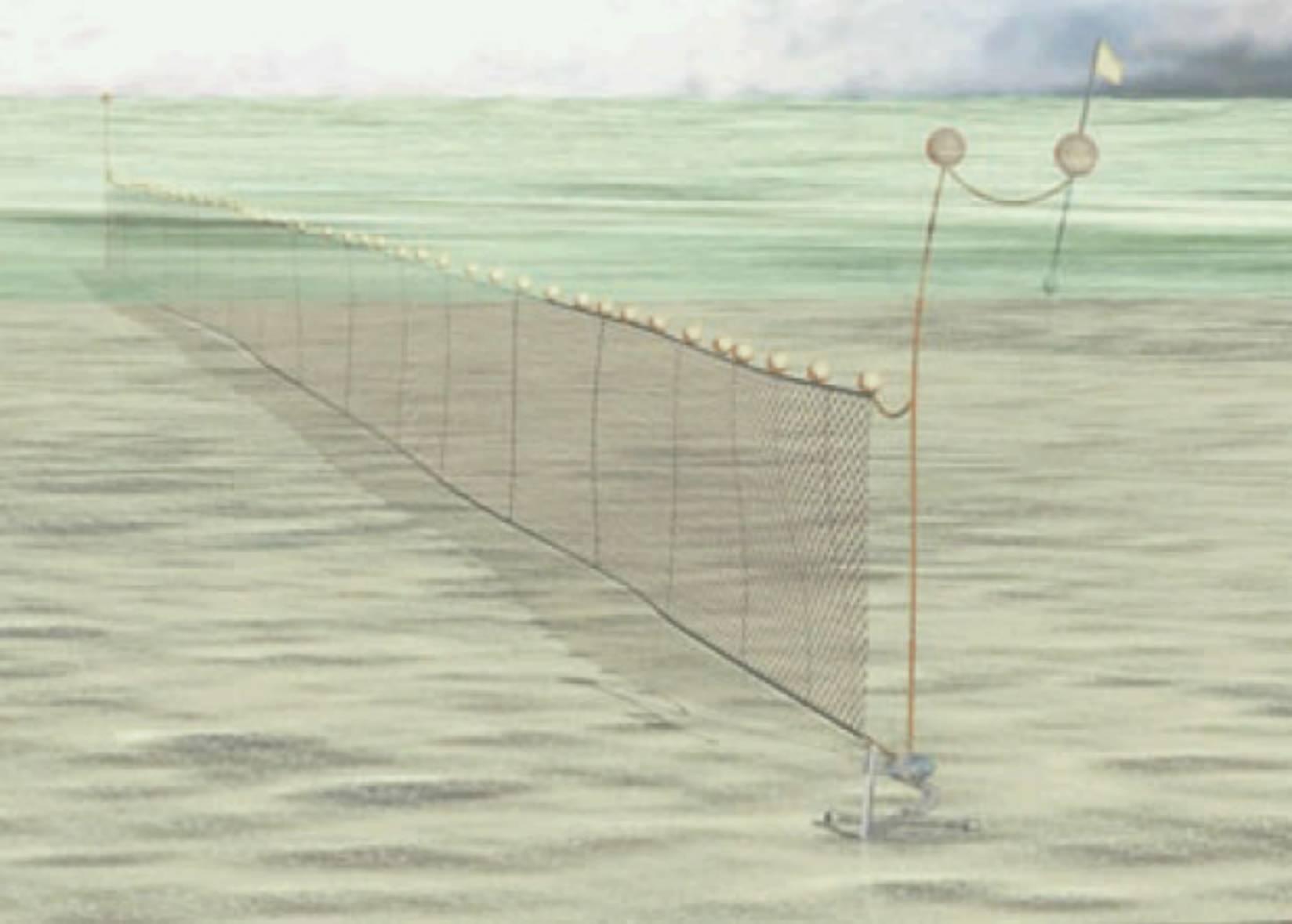





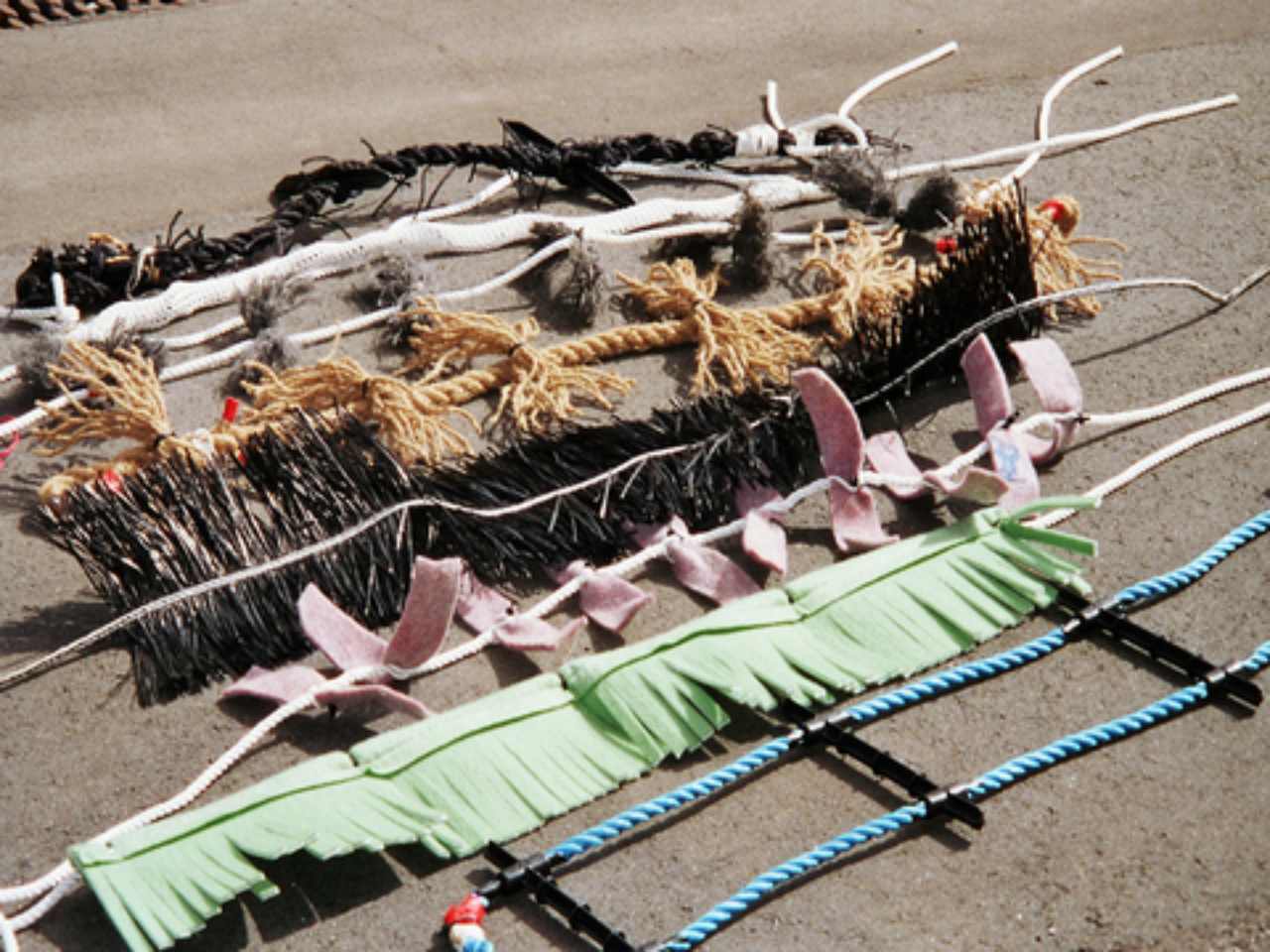









NOTE: THE
2000-2-1-0000000000
00000000000000000000
00000000000000000000



A izquierda



A derecha

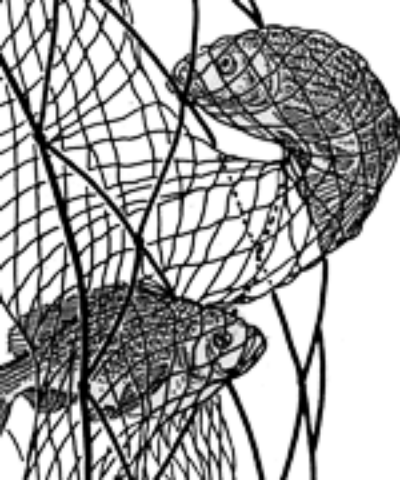

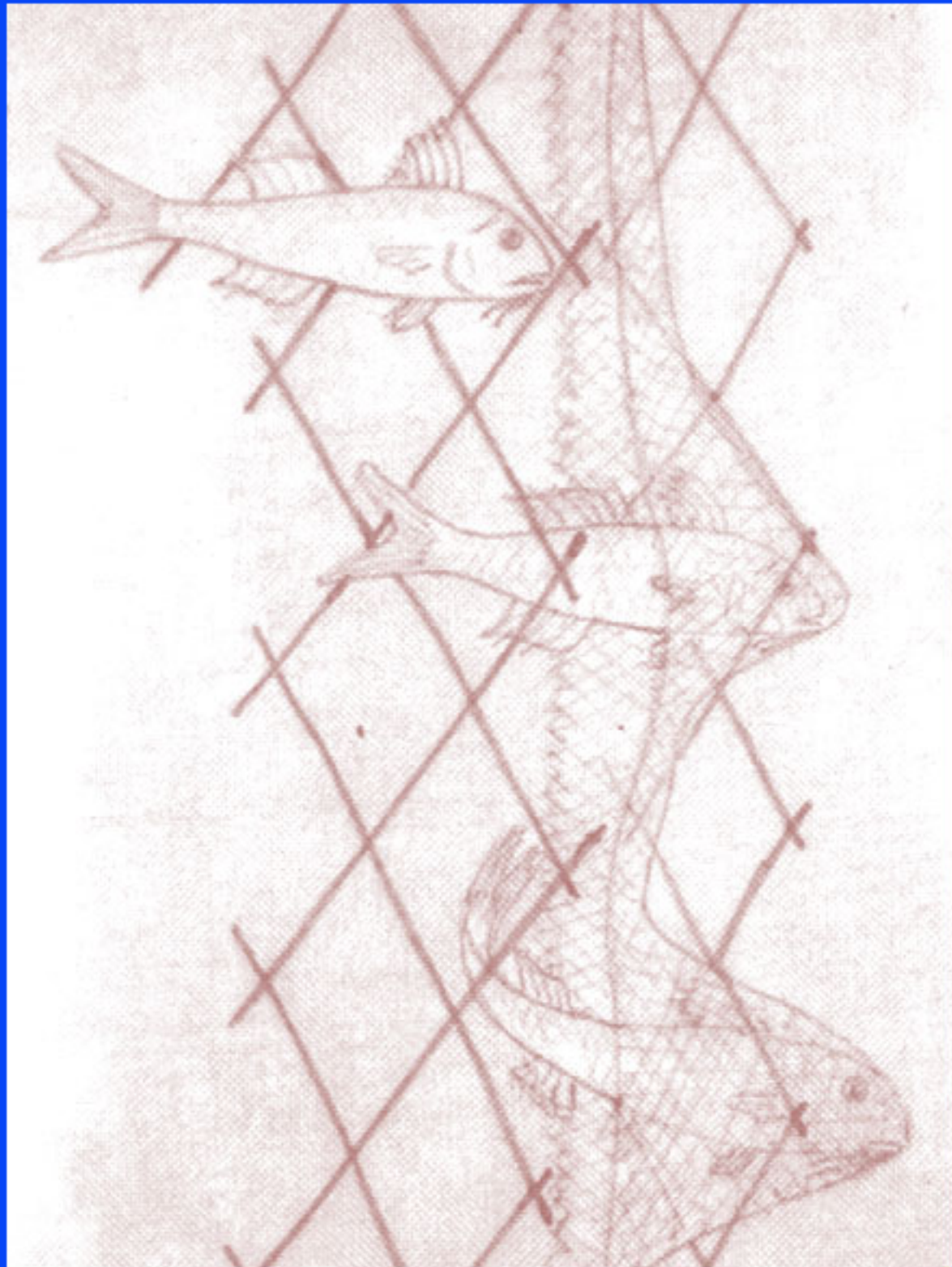

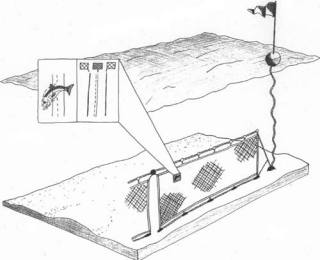





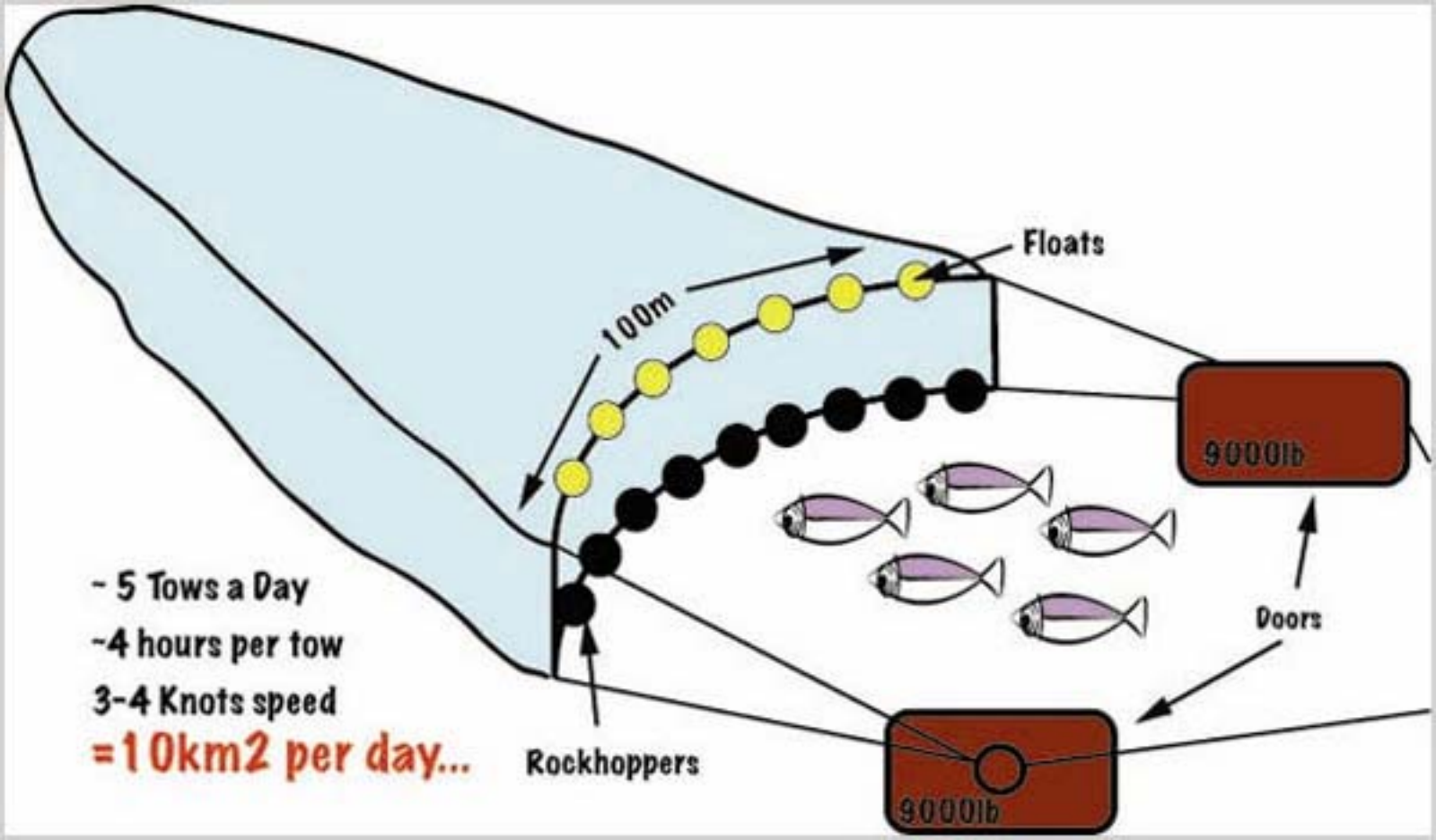





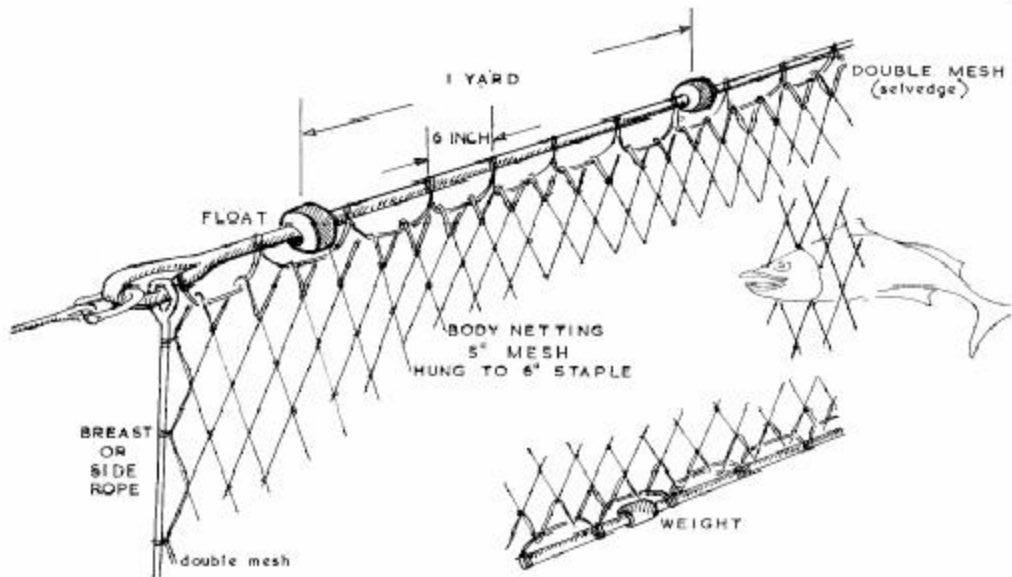

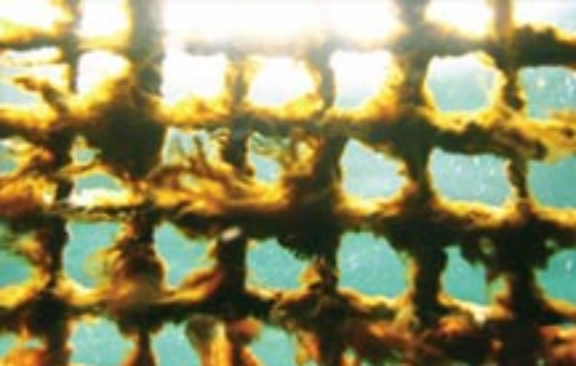

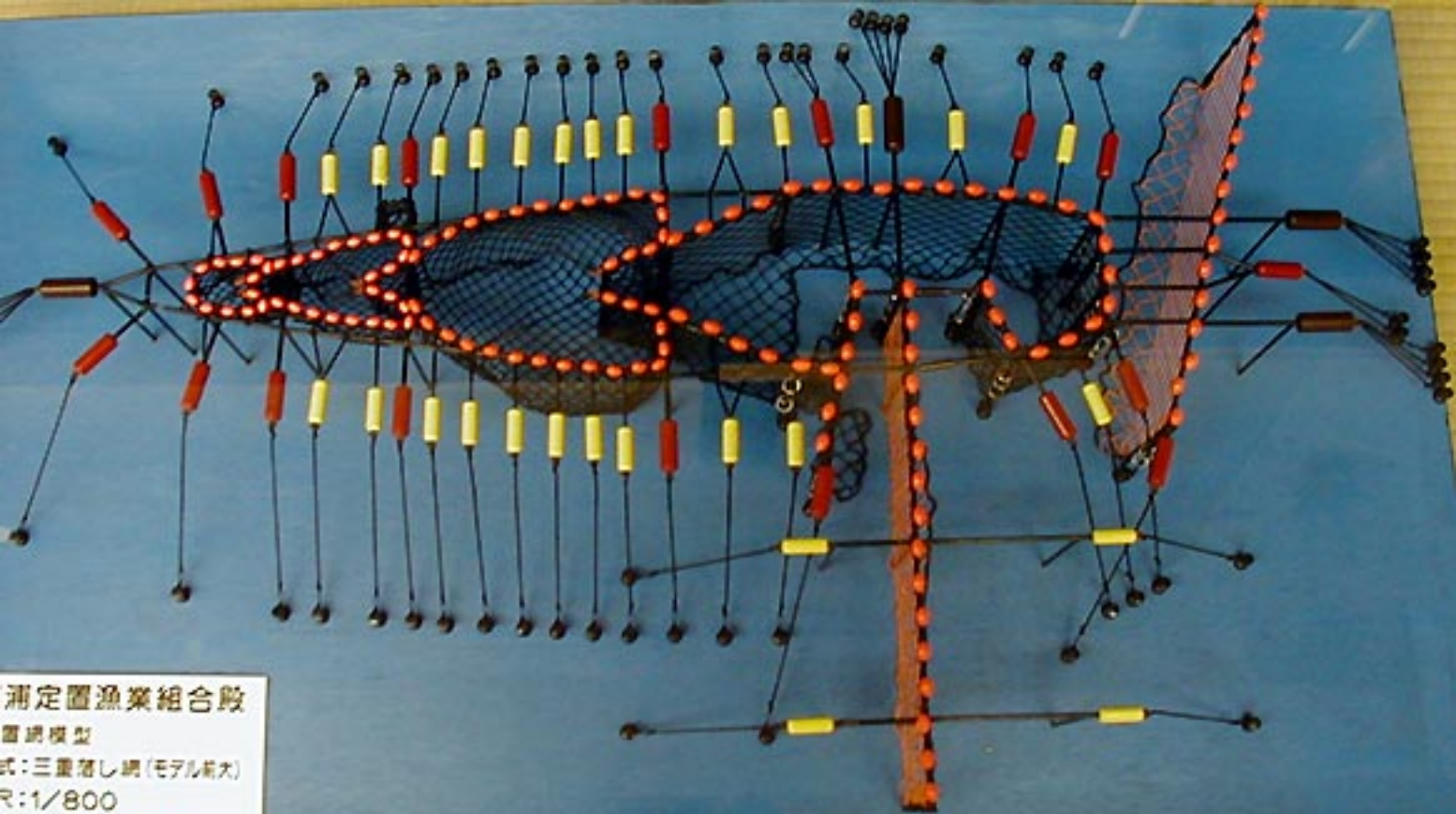

浦定置漁業組合殿

置網模型

式：三重落し網（モデル網大）

尺：1/800

製：日東製網株式会社

〒100-0001 東京都千代田区千代田

























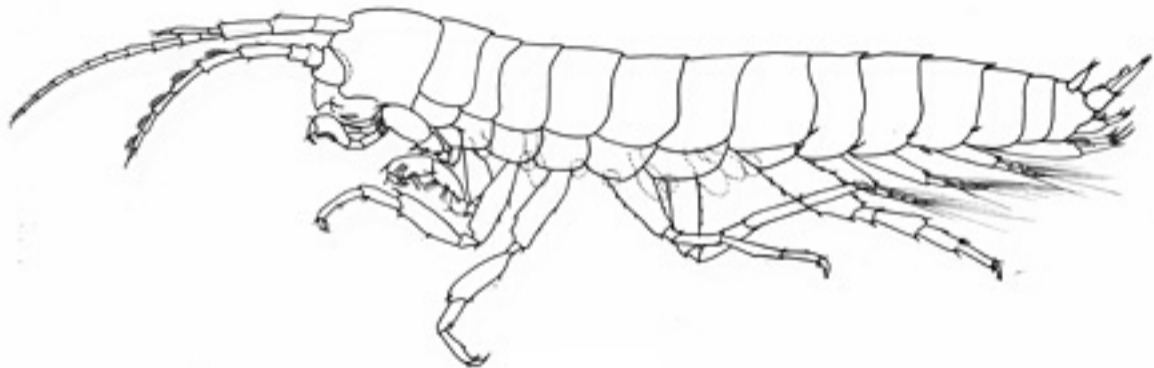



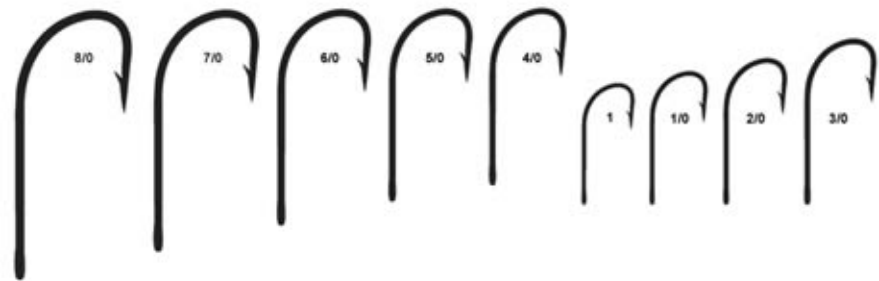

Mustad 

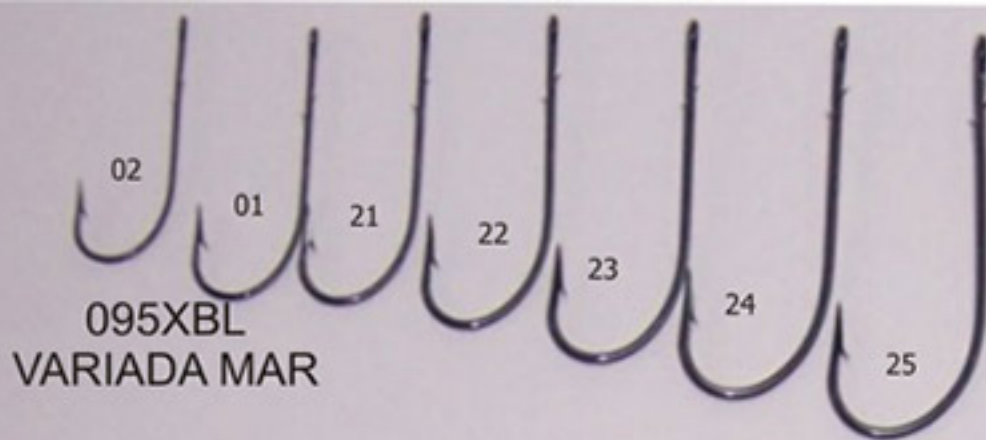

095XBL
VARIADA MAR



254 N
VARIADA RIO MAR

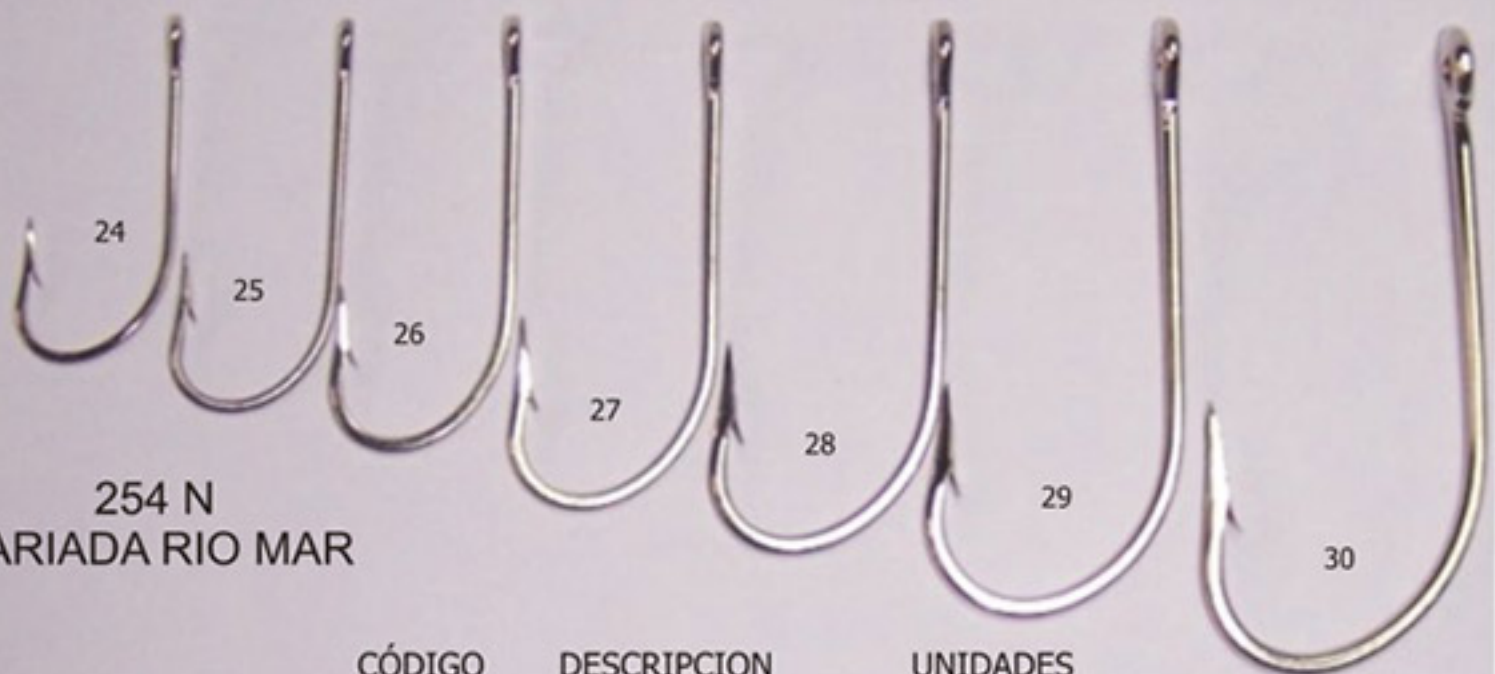

254 N
VARIADA RIO MAR

CÓDIGO	DESCRIPCION	UNIDADES X BOLSA
--------	-------------	---------------------

3309-02	ANZUELO 095XBL 2	10
3309-01	ANZUELO 095XBL 1	10
3309-21	ANZUELO 095XBL 1/0	10
3309-22	ANZUELO 095XBL 2/0	8
3309-23	ANZUELO 095XBL 3/0	7
3309-24	ANZUELO 095XBL 4/0	7
3309-25	ANZUELO 095XBL 5/0	6
3316-02	ANZUELO 254N 2	10
3316-01	ANZUELO 254N 1	10
3316-22	ANZUELO 254N 2/0	8
3316-23	ANZUELO 254N 3/0	7
3316-24	ANZUELO 254N 4/0	6
3316-25	ANZUELO 254N 5/0	6
3316-26	ANZUELO 254N 6/0	5
3316-27	ANZUELO 254N 7/0	9
3316-28	ANZUELO 254N 8/0	7
3316-29	ANZUELO 254N 9/0	6
3316-30	ANZUELO 254N 10/0	4
3316-31	ANZUELO 254N 11/0	3





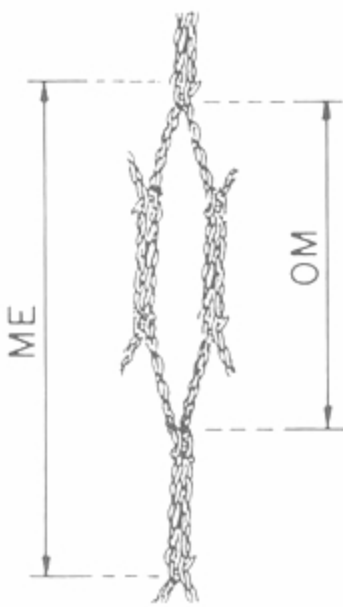
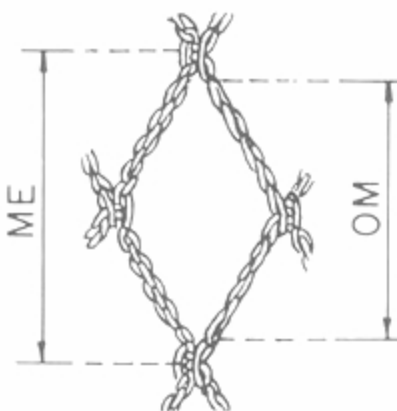
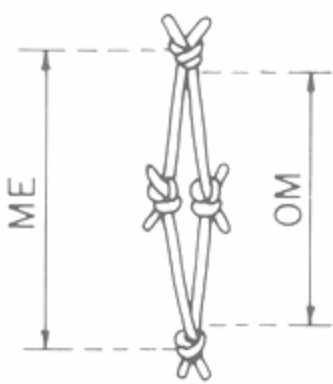

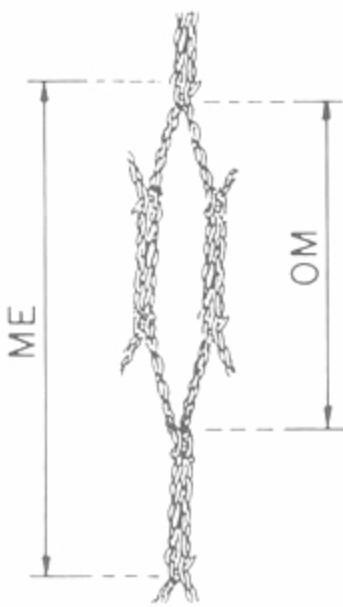
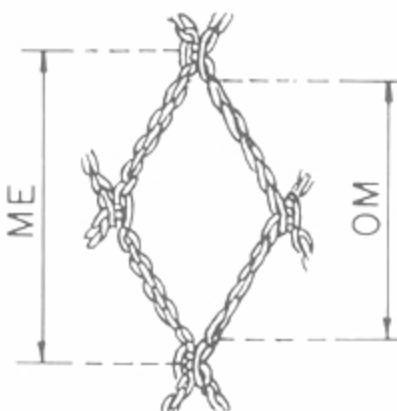
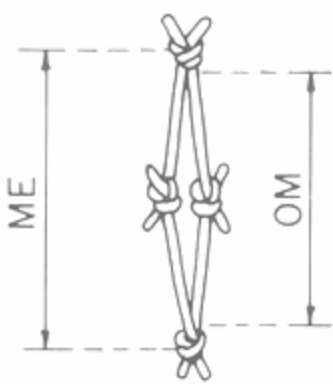



Punta de Hawaiana a detalle



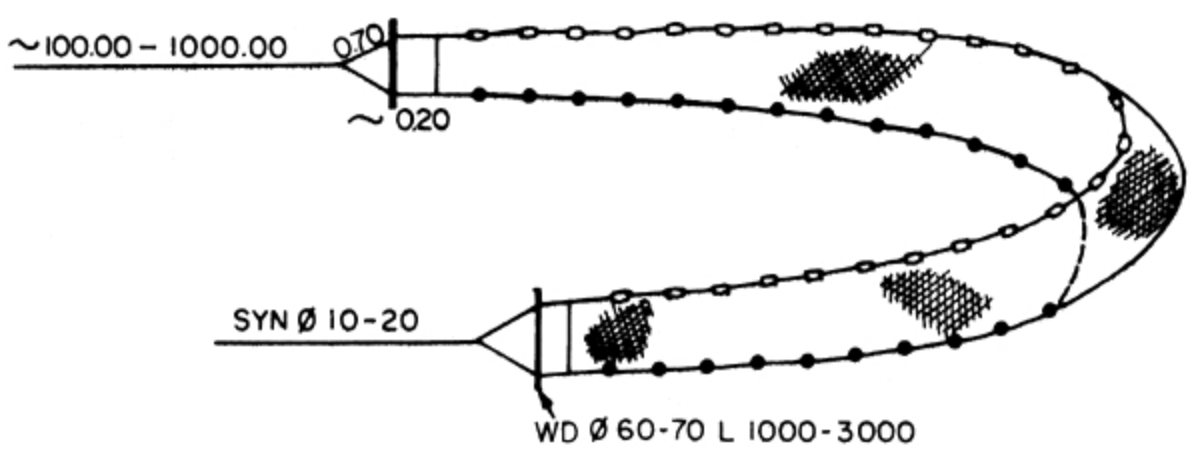

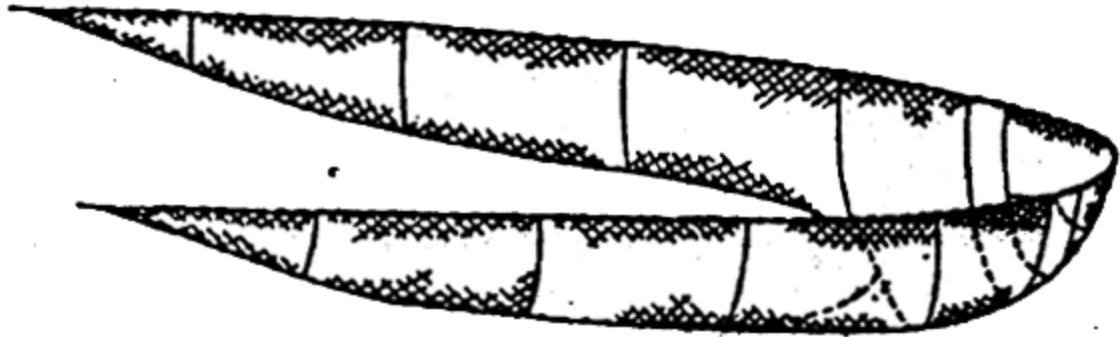







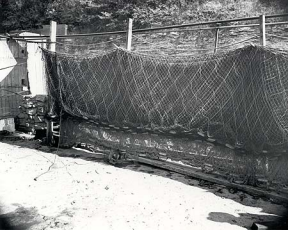



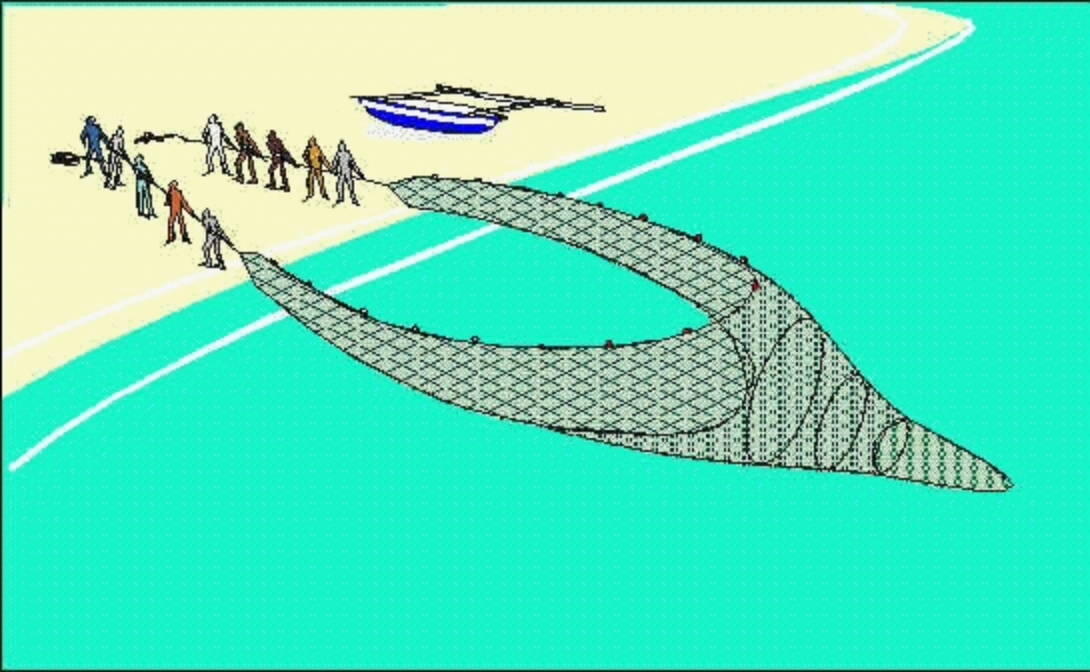



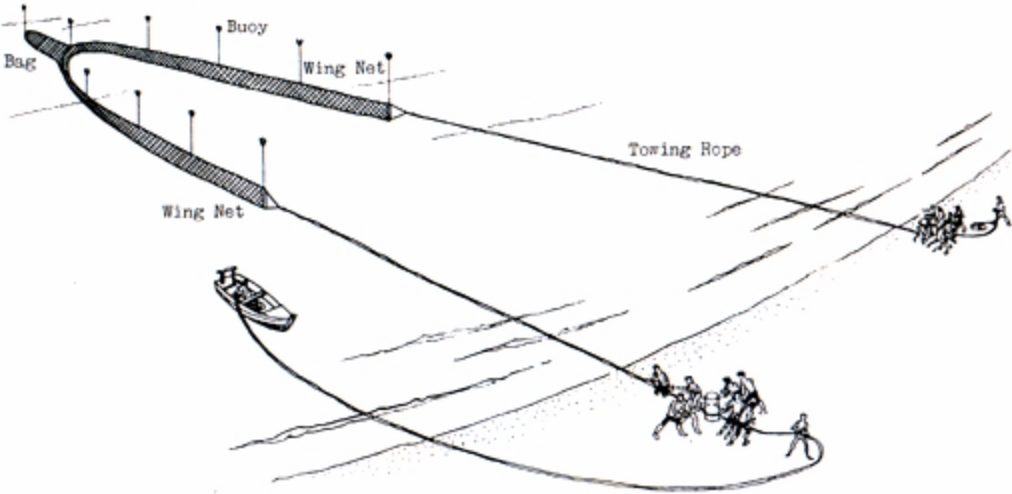





2035/11/06



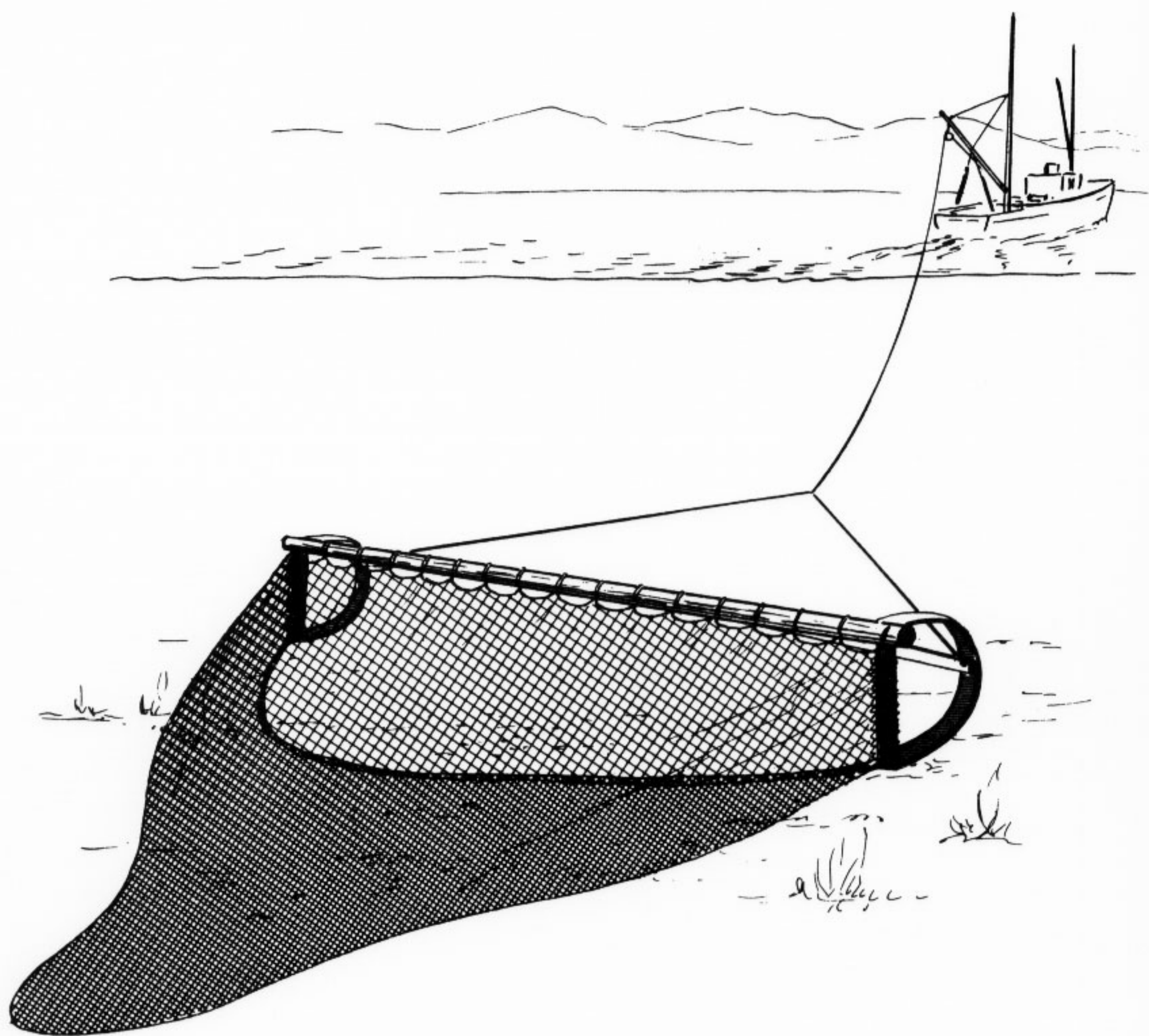

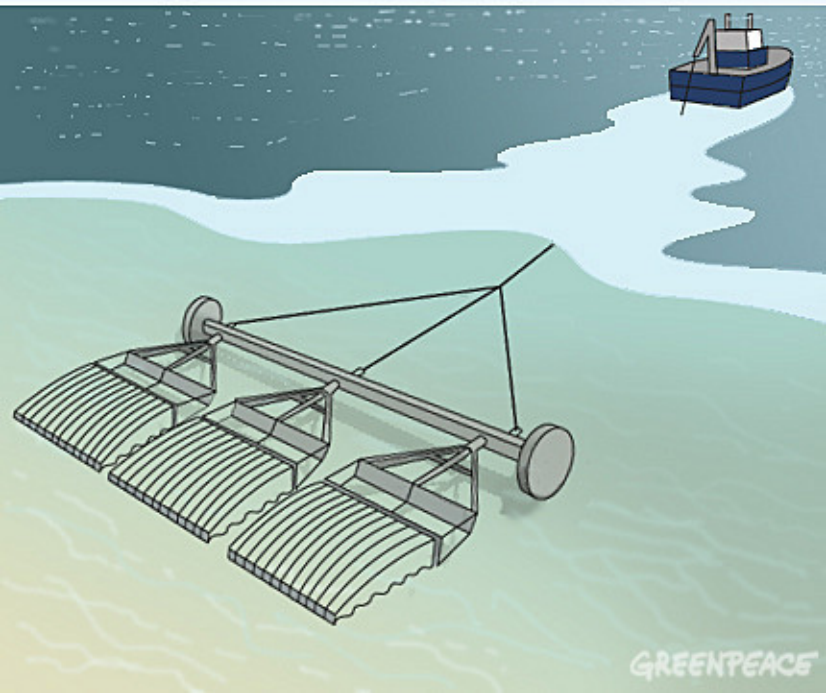

GREENPEACE

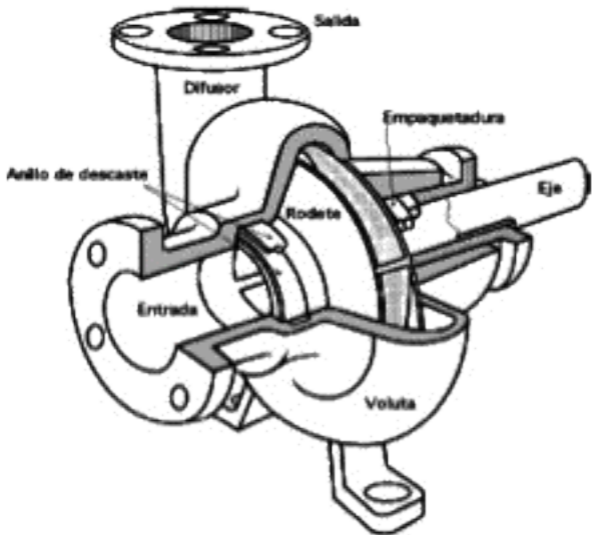

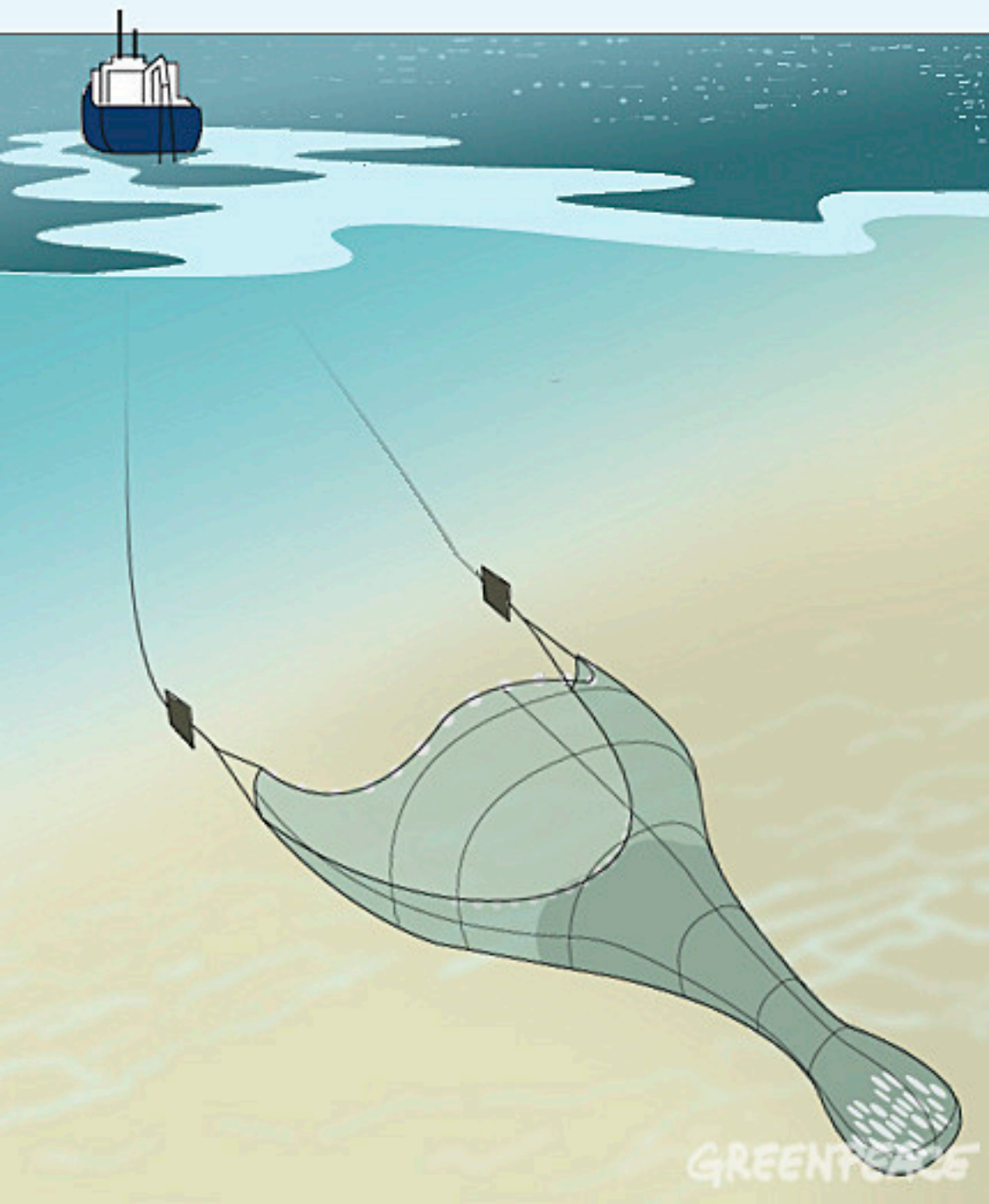

GREENY 016

Tipo Izango

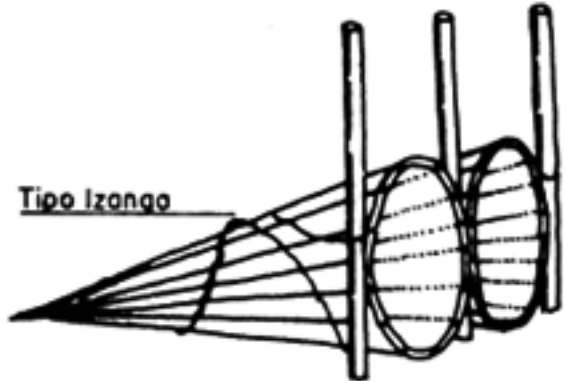

Tipo Chauco

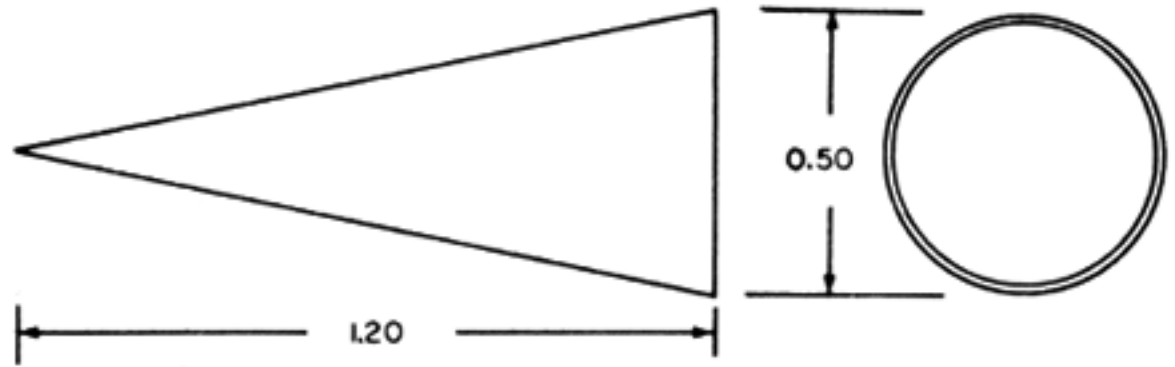

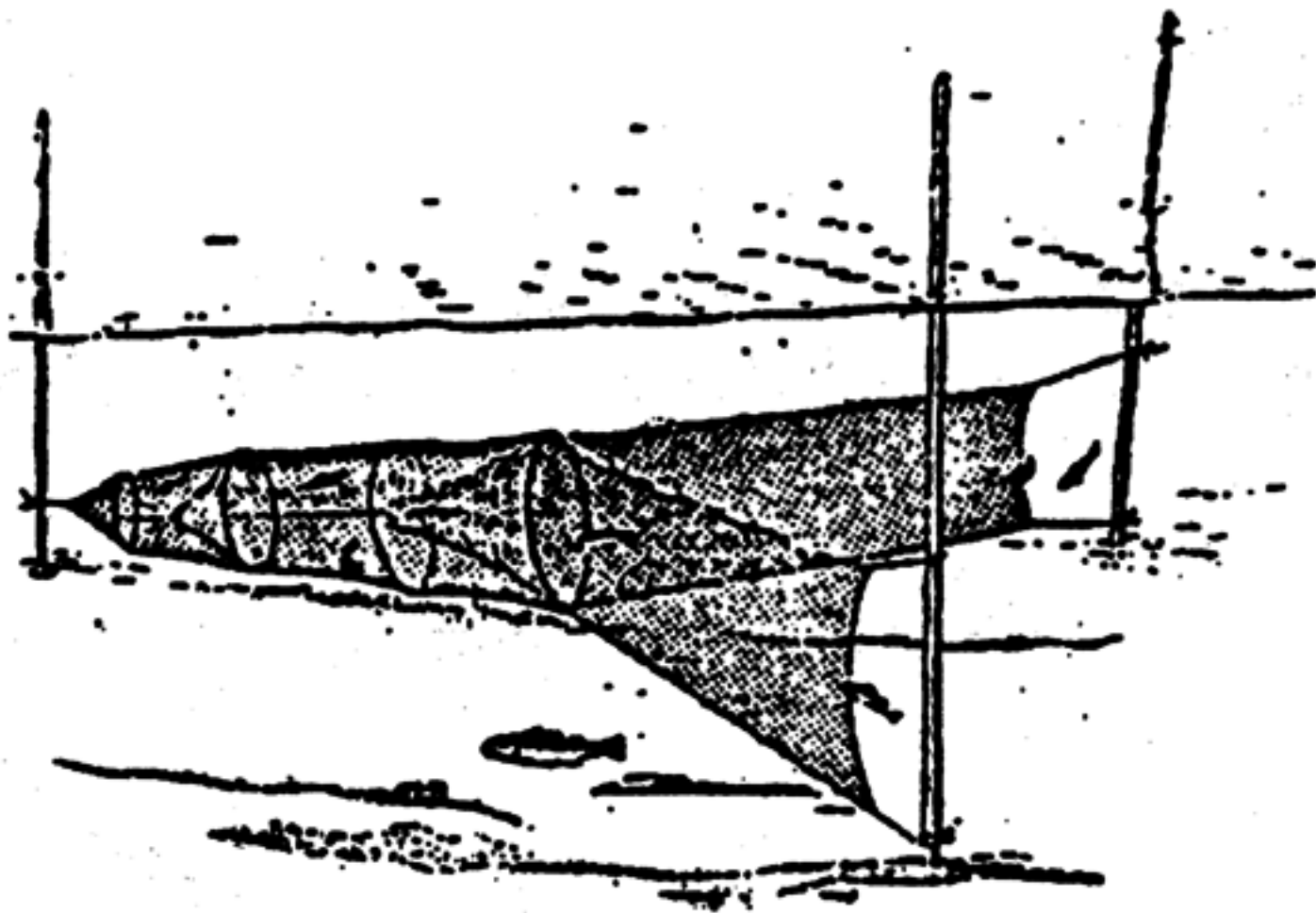















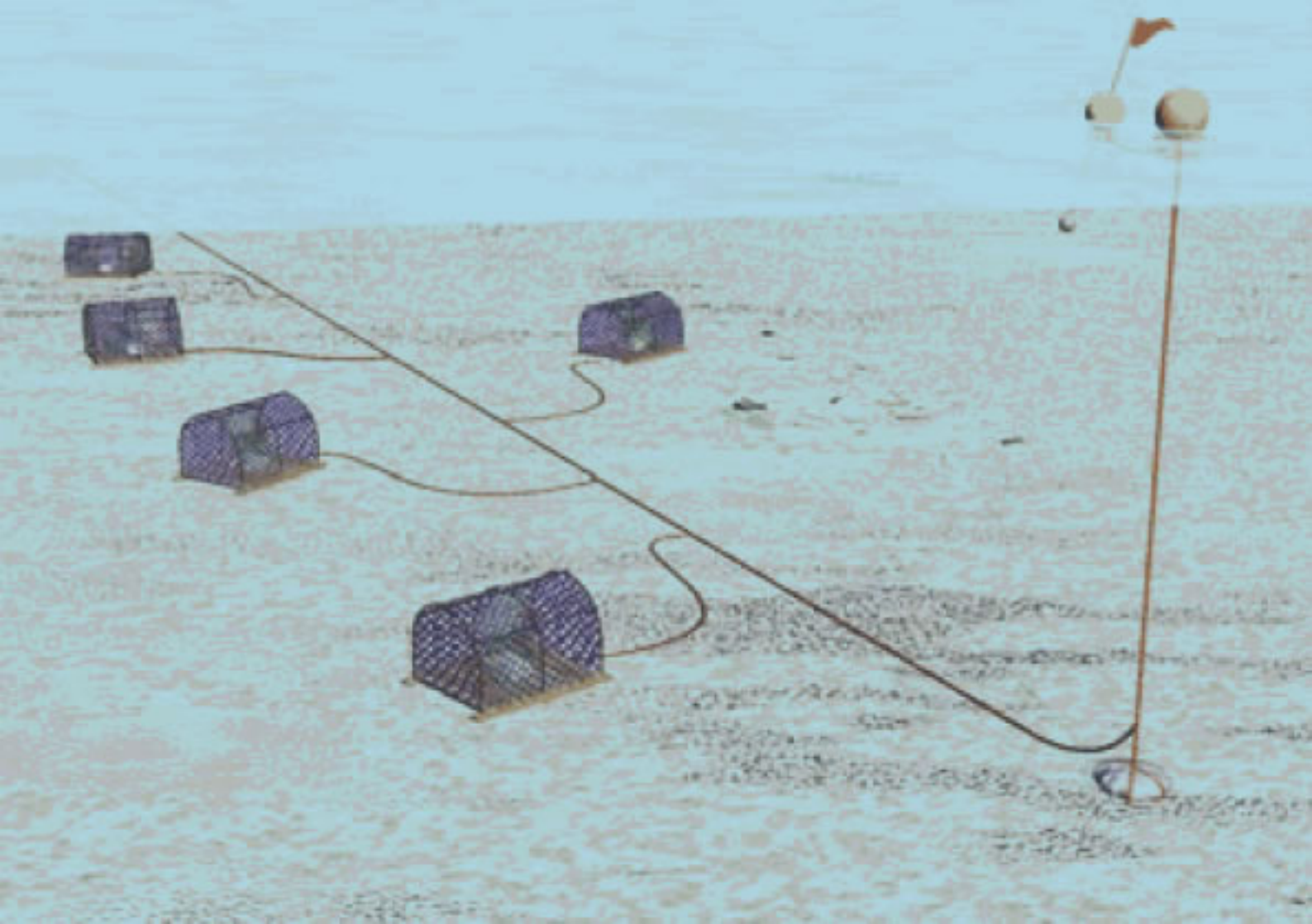

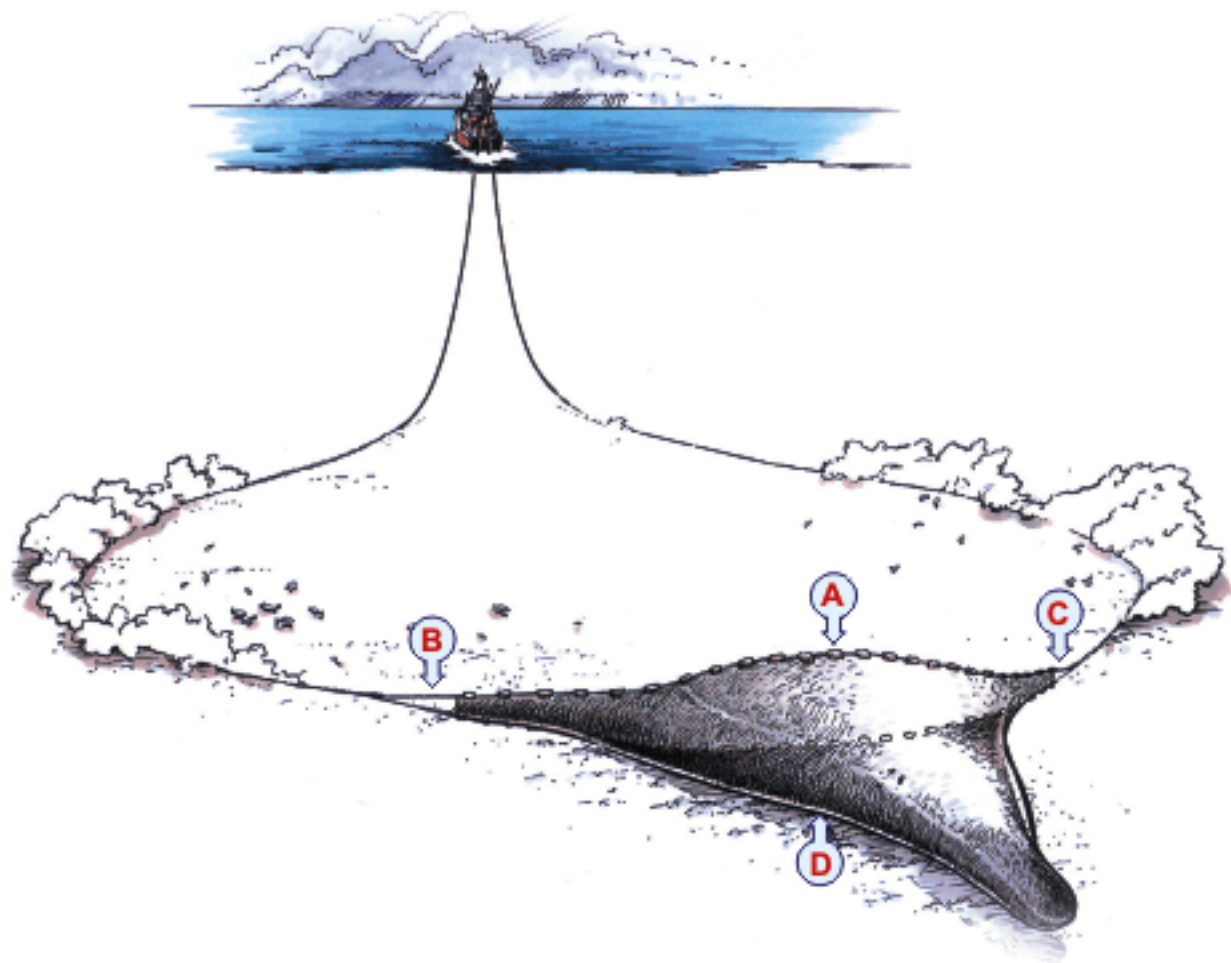



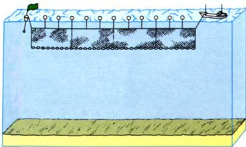

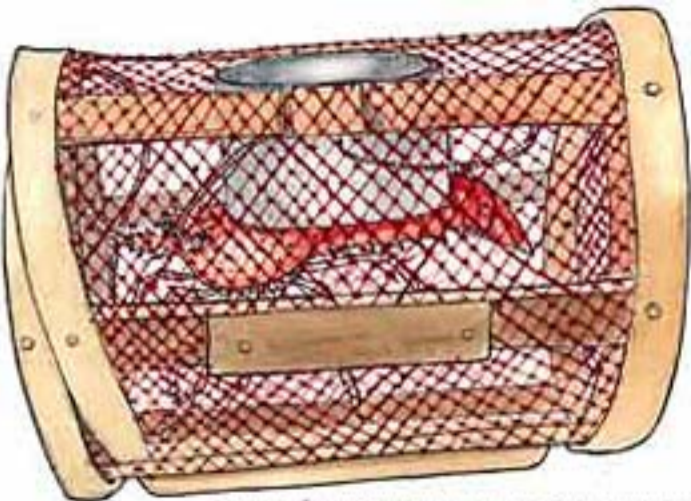

© 2005 Ángel Domínguez para AZTI-Tecnalia



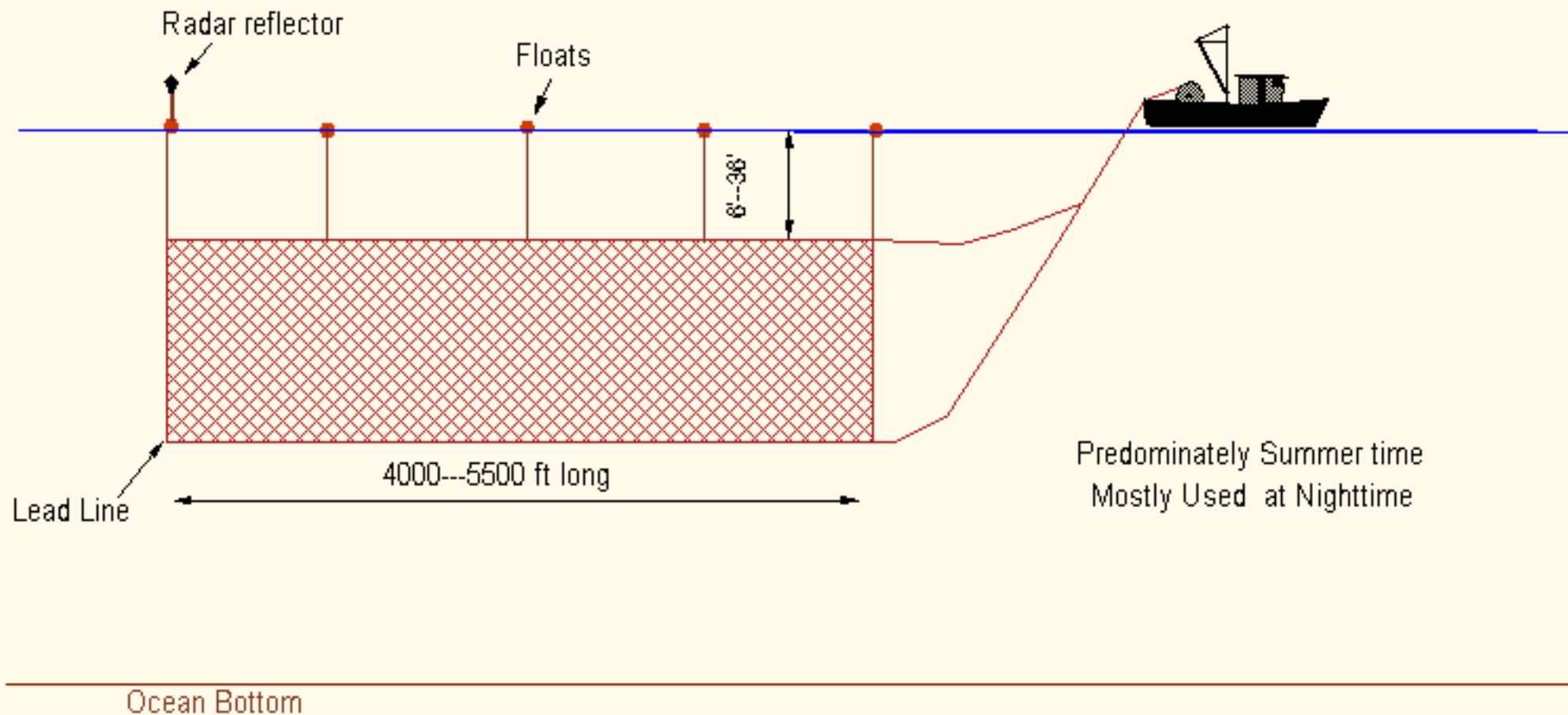

Drift Gillnet

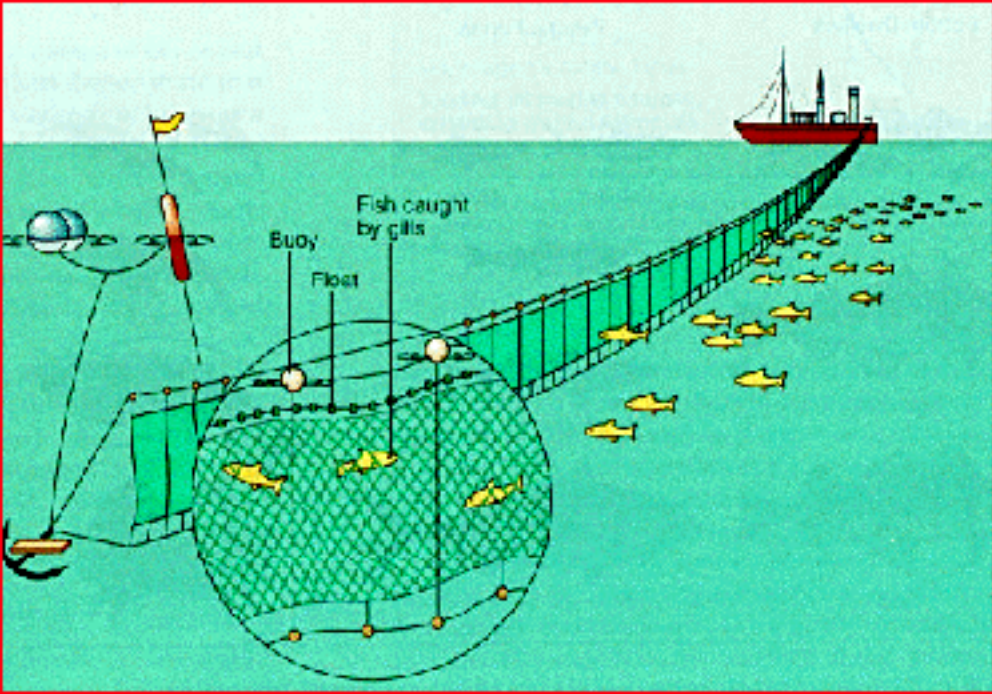

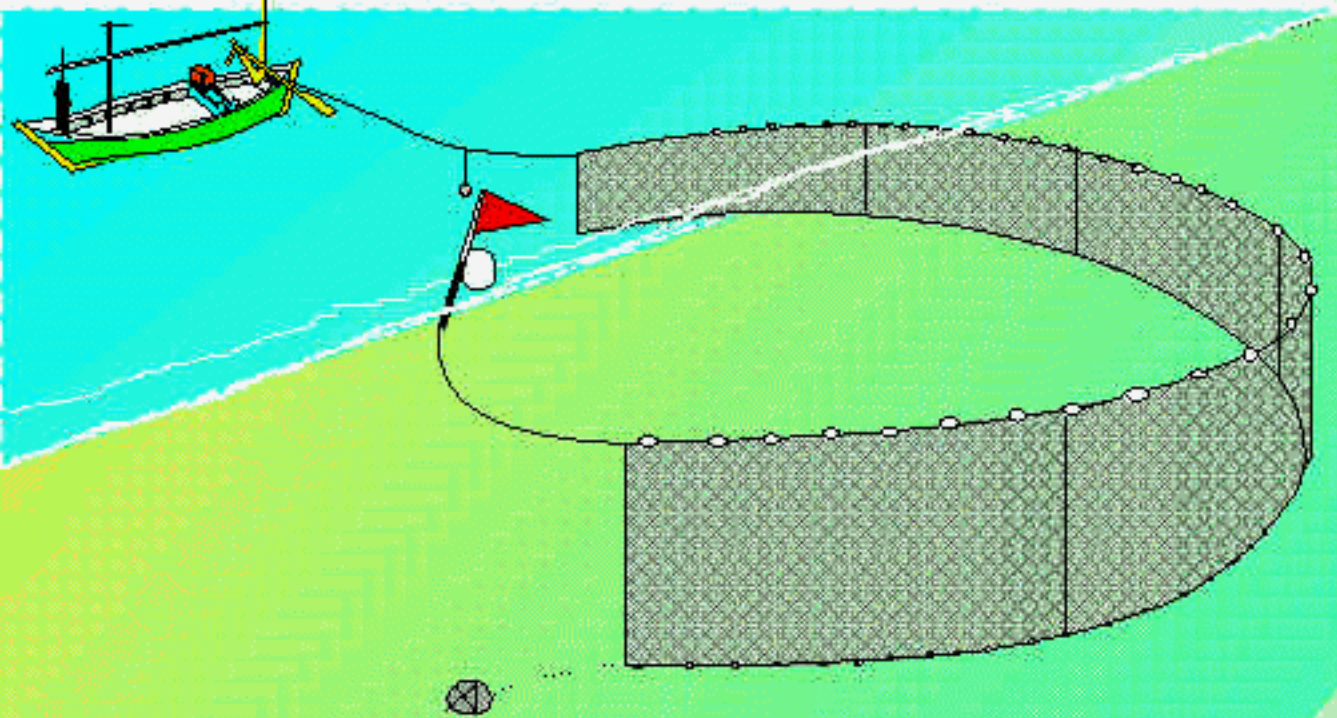







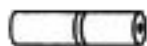

FL125

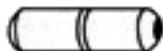

FL200



FL245



FL250



HD1



FL130



SB1



SB2



SB3



SB4-5



SB6-7



SB8-10-11



OS6



OS1SC

OS2 -OS4SC

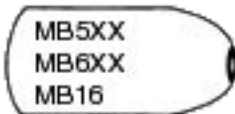

MB5XX

MB6XX

MB16

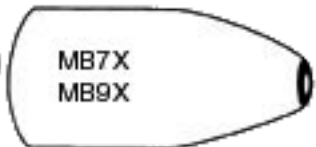

MB7X

MB9X

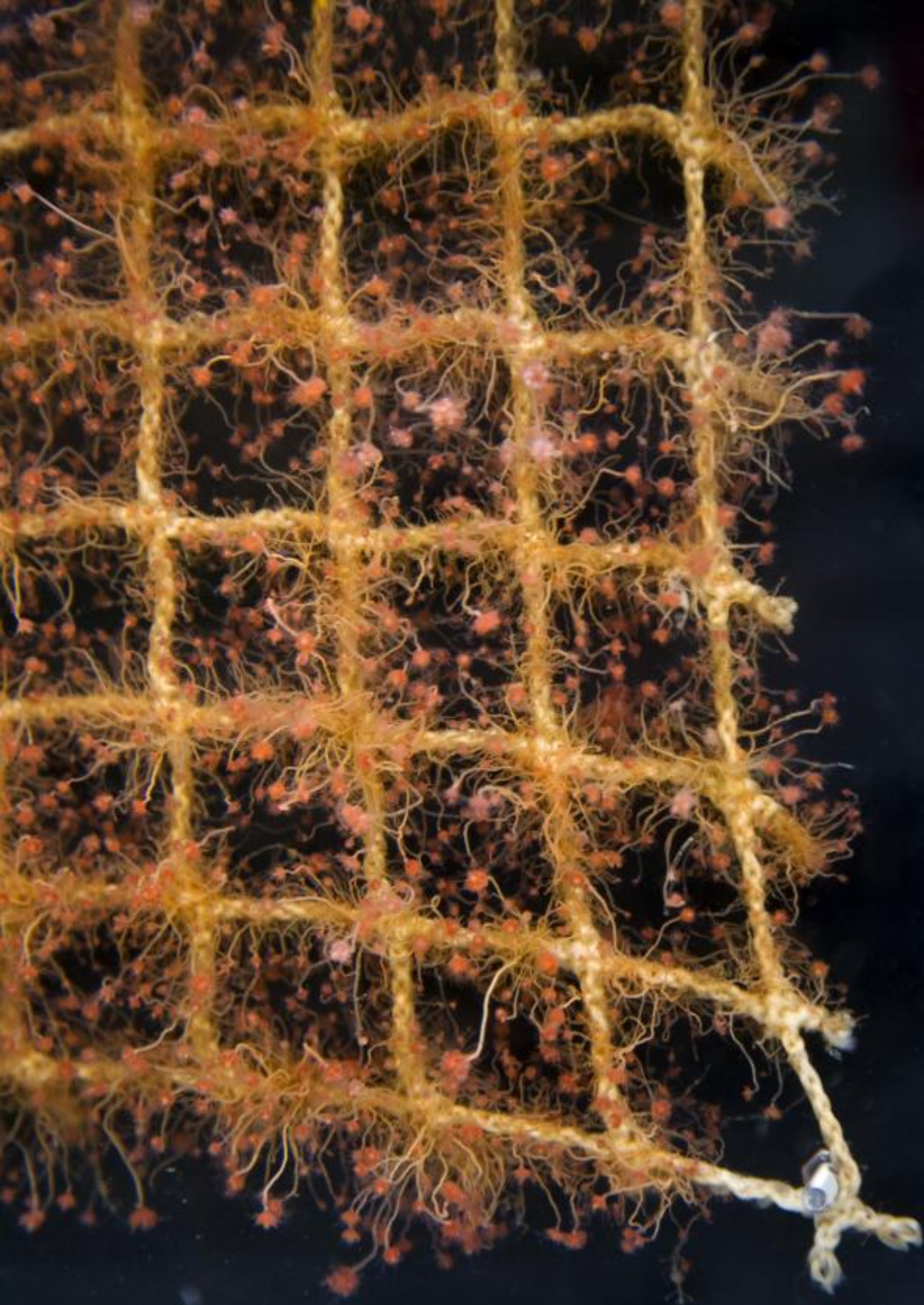



3 16 02







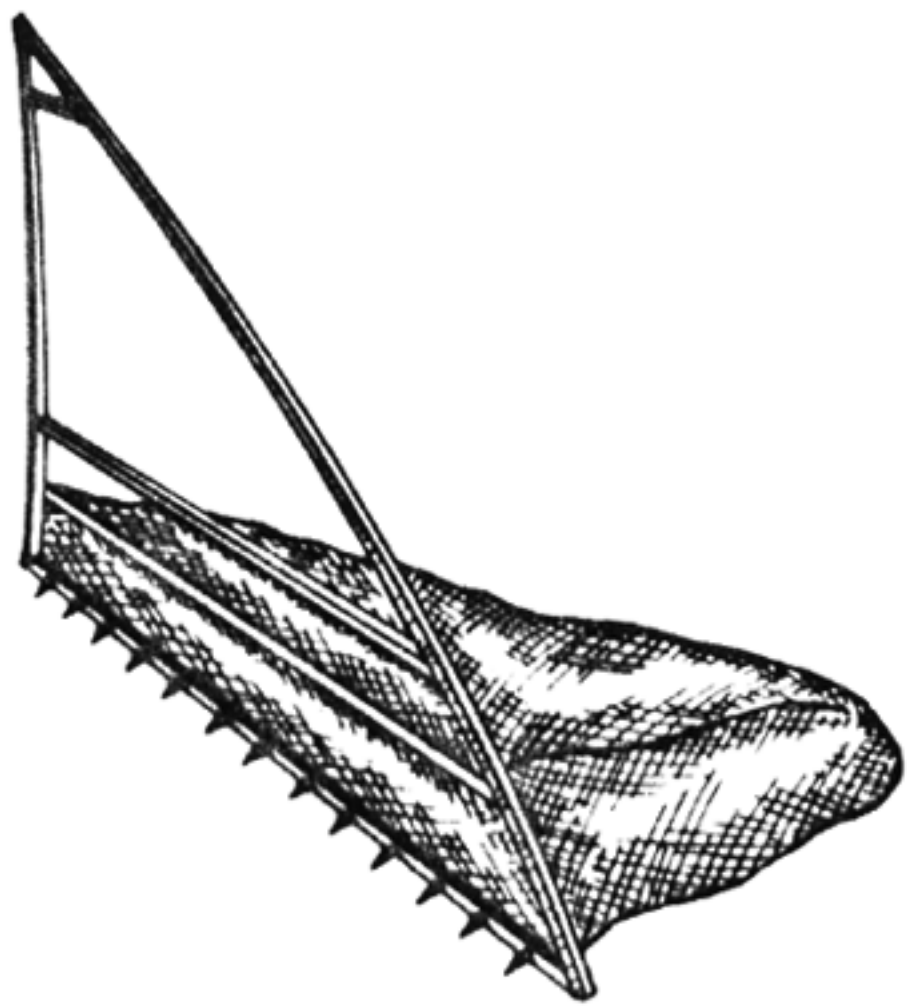

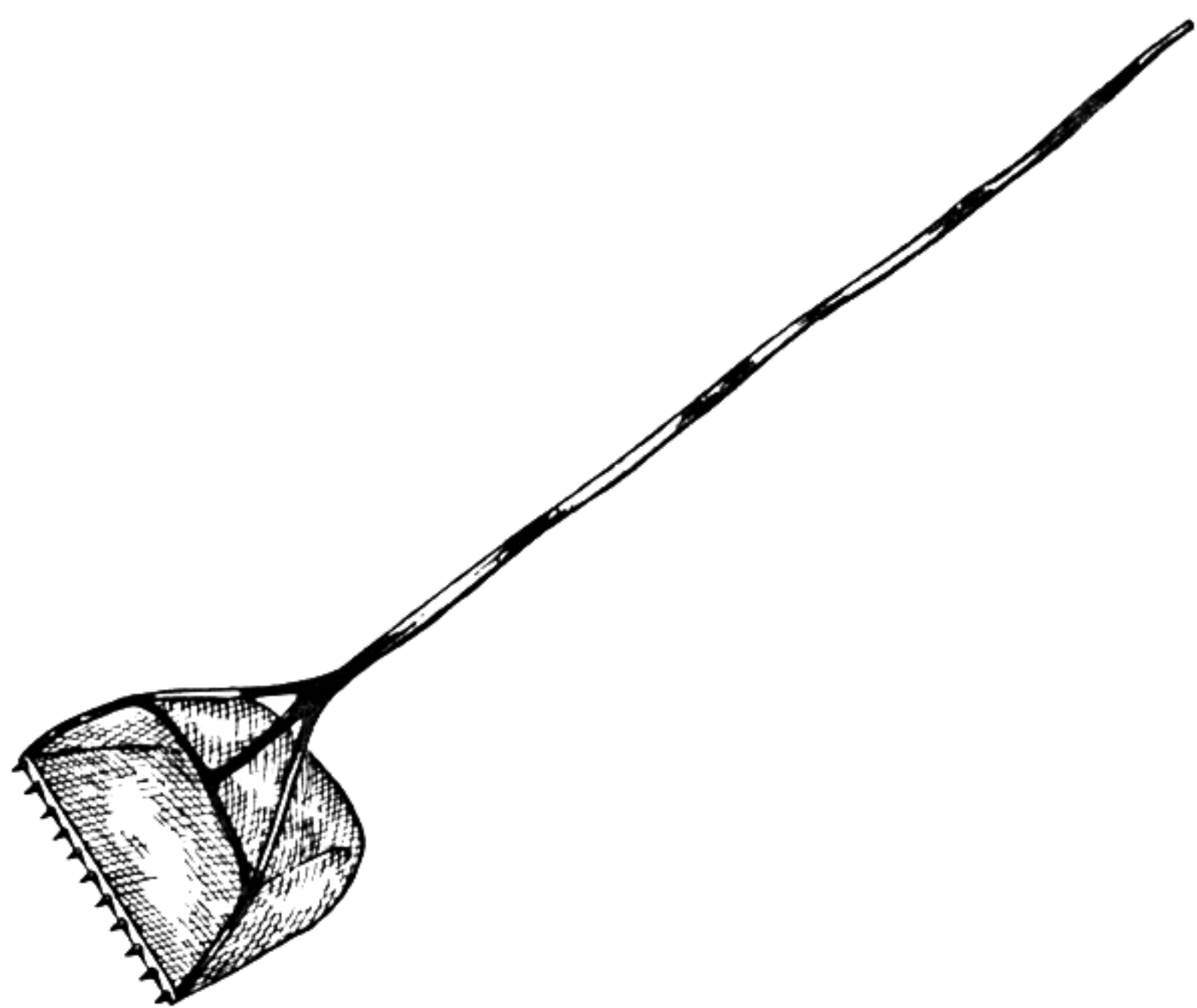

**1 MEDIUM SHUTTLE
WIND TWINE ON SHUTTLE
UNTIL FULL
HOLDS 5 TO 10 YARDS**

**WRAP TWICE AROUND
GAGE STICK, TIE TIGHT,
TIE AGAIN, THEN SLIP
LOOP OFF AND HANG
ON NAIL**

**NOTICE POSITION
OF FIRST KNOT**

**GAGE
STICK**

2

PULL DOWN

3

**PULL
HARD**

4

**PINCH & HOLD TIGHT
WHILE KNOT IS
BEING TIED**

5

**HIDDEN VIEW
OF NO. 4**

6

**LEFT THUMB & FORE-
FINGER MUST CONTINUE
PINCHING WHILE KNOT
IS TIGHTENING**

**RIGHT HAND...
PULL TWINE
OUTWARD
THEN
DOWN**

7

8

RIGHT WRONG

IMPORTANT!

**WHILE TIGHTENING,
DON'T LET KNOT
SLIP BELOW "V"**

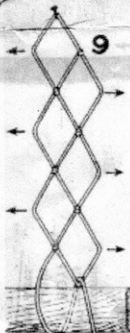

**PULL
DOWN**

**9 MAKE A CHAIN OF
STARTING MESHES
BY TYING KNOTS AS
IN NO. 4. AFTER
EACH KNOT IS TIED
PULL OUT THE GAGE
STICK AND TIE AN-
OTHER AS SHOWN
HERE.
STRAIGHTEN OUT
MESHERS BY PULLING
WITH FINGERS AS
SHOWN BY ARROWS**



**10 THREAD THE STARTING MESHES ON A
STIFF ROD AS SHOWN ABOVE. THEN
BEGIN NEXT ROW AS SHOWN IN
FIGURE 11. PINCH AT "B" AND
TIE EXACTLY AS SHOWN IN
FIGS. 4, 5 & 6. KEEP TWINE
TIGHT ON GAGE STICK.
THE NEWLY MADE MESHES
SHOULD BE LEFT ON GAGE
STICK UNTIL CROWDED,
THEN SLIP OFF SOME. AT END
OF ROW, PULL GAGE STICK
OUT, TURN ROD END FOR
END AND START OVER...
PULL KNOTS TIGHT!**

11

PULL

PULL

B

103
101
102
104
105
106
107
108
109
110
111
112
113
114
115
116
117
118
119
120
121
122
123
124
125
126
127
128
129
130
131
132
133
134
135
136
137
138
139
140
141
142
143
144
145
146
147
148
149
150
151
152
153
154
155
156
157
158
159
160
161
162
163
164
165
166
167
168
169
170
171
172
173
174
175
176
177
178
179
180
181
182
183
184
185
186
187
188
189
190
191
192
193
194
195
196
197
198
199
200



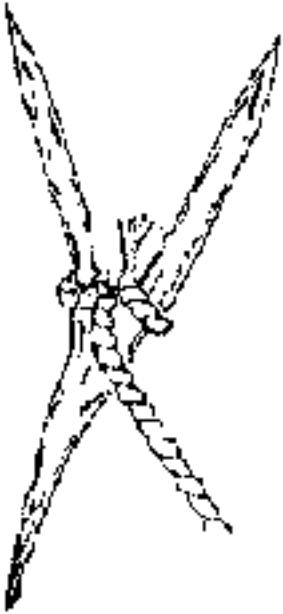

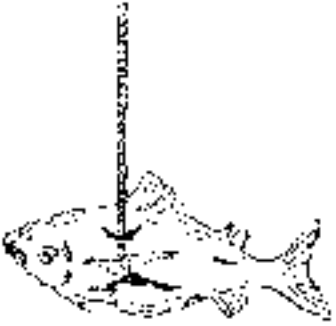

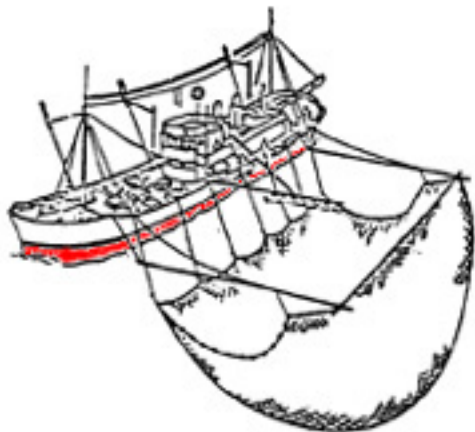
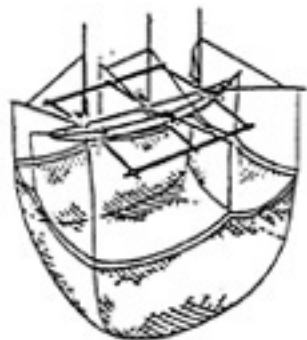





retex





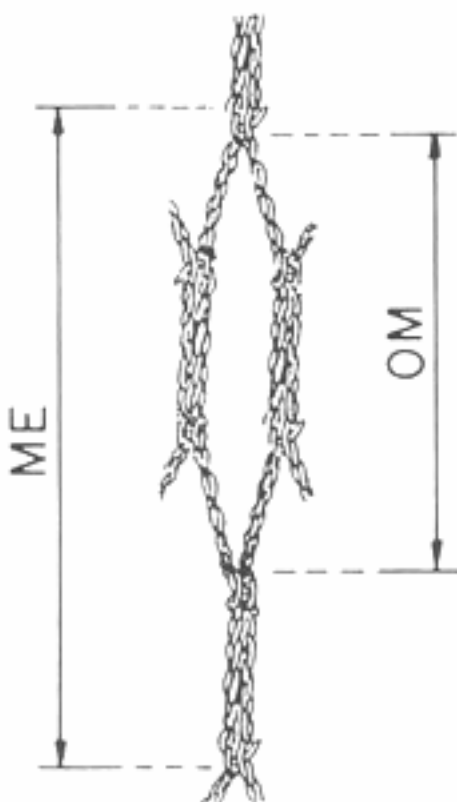
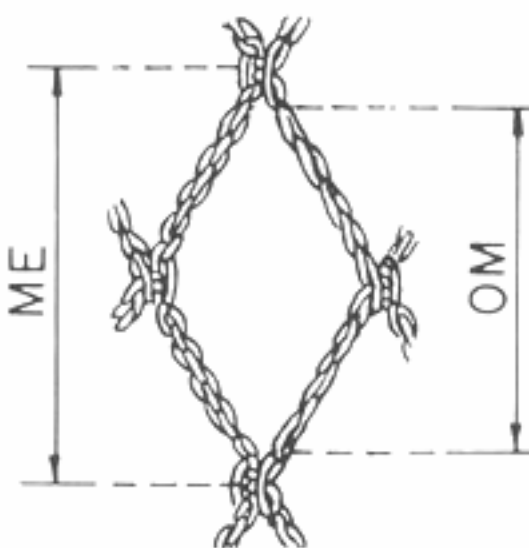
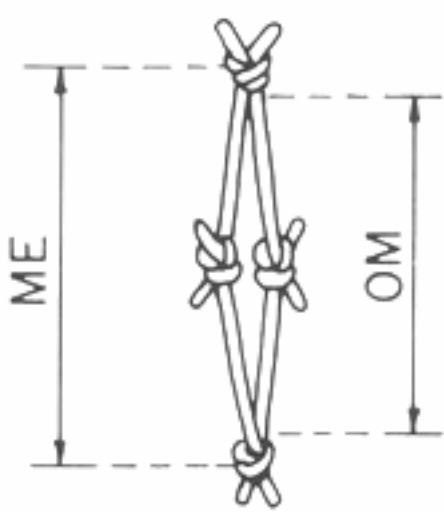

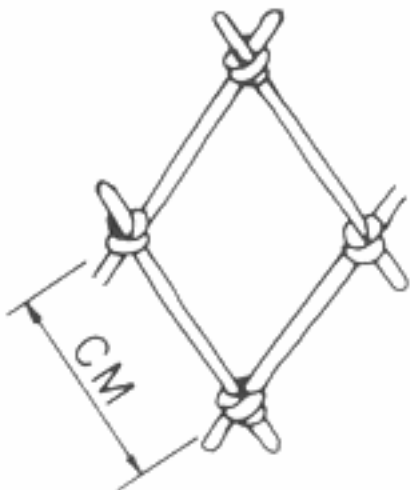

Red de nudos

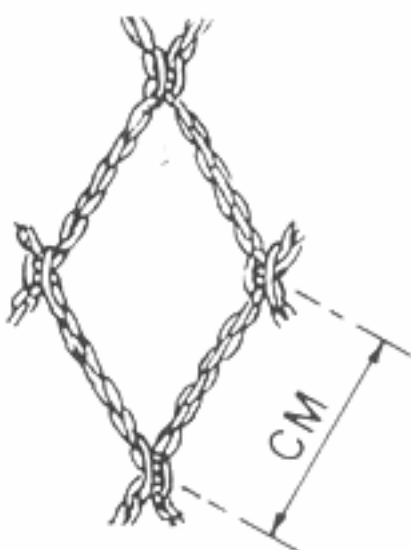

**Red sin nudos
(tipo Raschel)**



Malla hexagonal

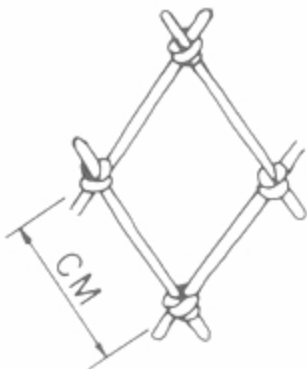

Red de nudos

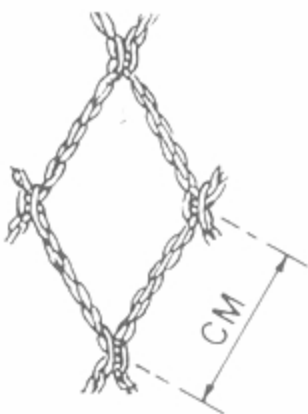

**Red sin nudos
(tipo Raschel)**



Malla hexagonal

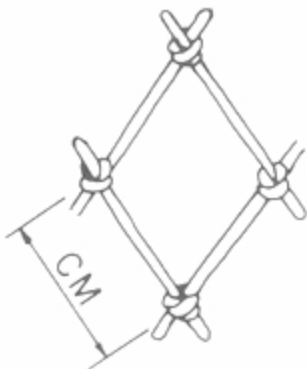

Red de nudos

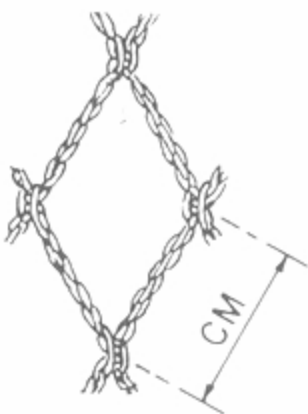

Red sin nudos
(tipo Raschel)



Malla hexagonal



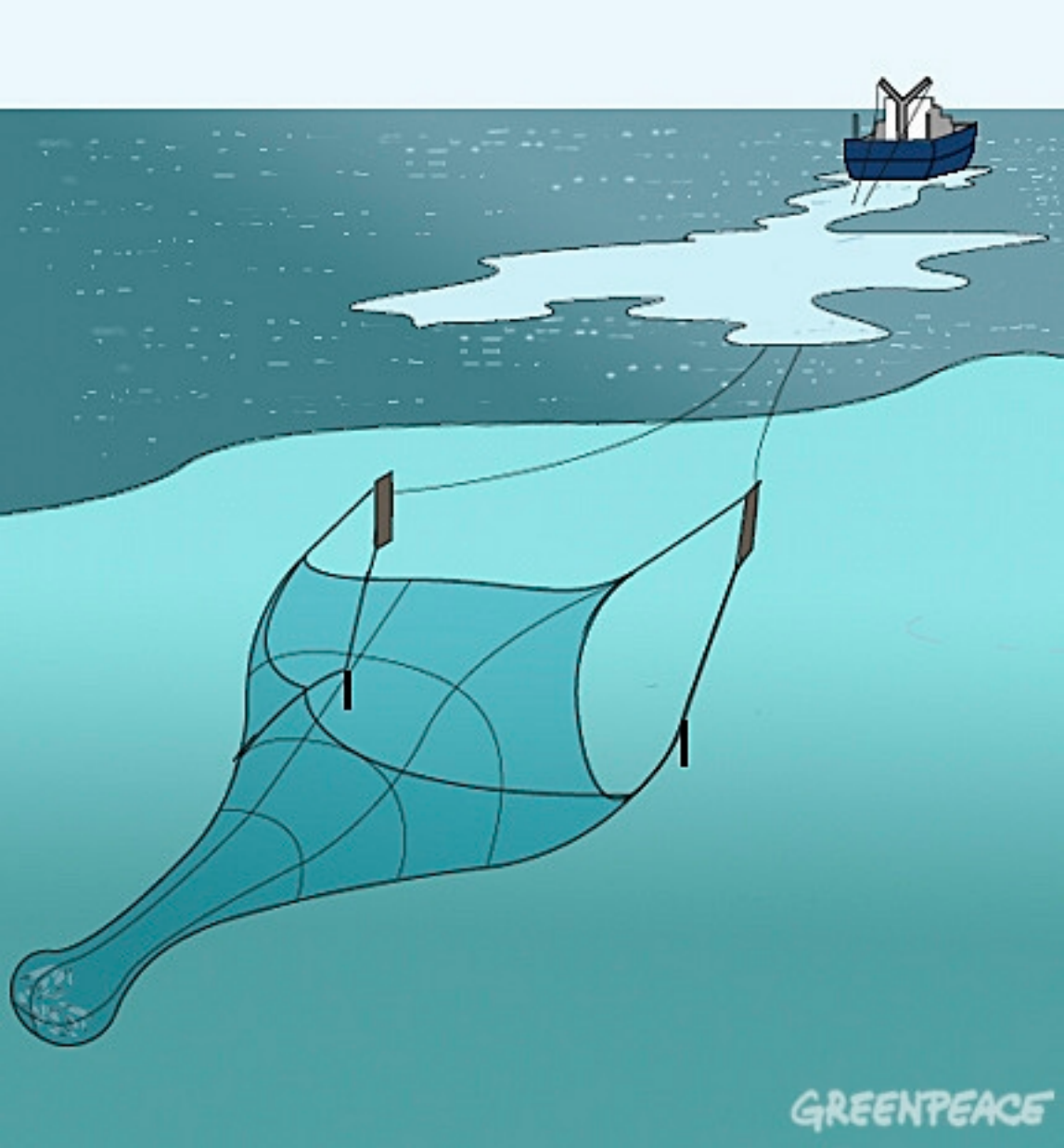

GREENPEACE

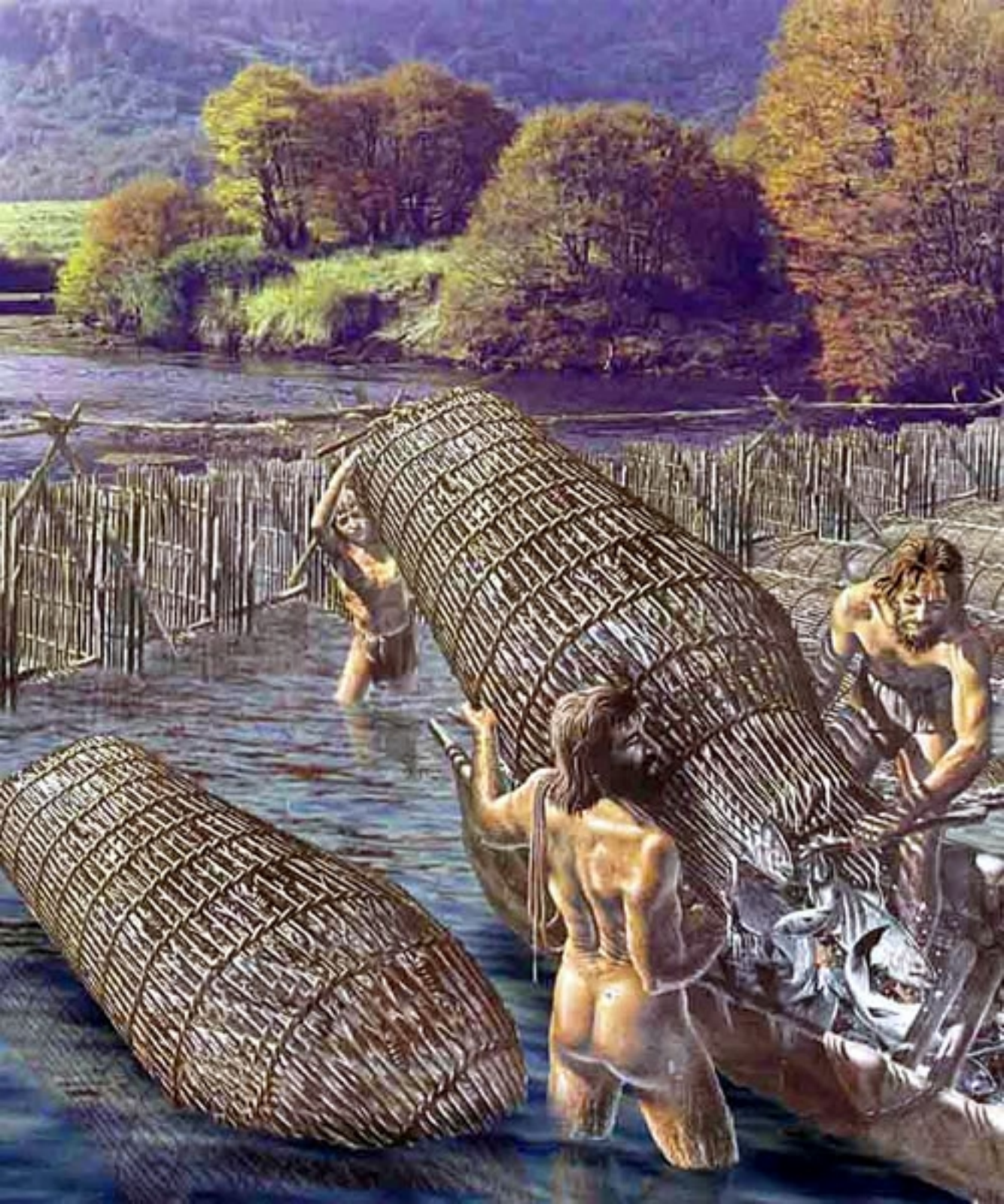

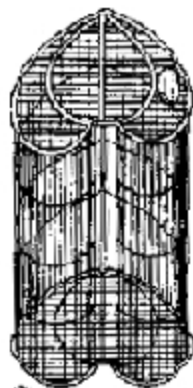

(A)

(B)

