

Vorläufig
Preliminary

Elektrische Eigenschaften / Electrical properties

Höchstzulässige Werte / Maximum rated values

Diode Gleichrichter/ Diode Rectifier

Periodische Rückw. Spitzensperrspannung repetitive peak reverse voltage	$T_{vj} = 25^{\circ}\text{C}$	V_{RRM}	800	V
Durchlaßstrom Grenzeffektivwert pro Chip RMS forward current per chip	$T_C = 80^{\circ}\text{C}$	I_{FRMSM}	23	A
Gleichrichter Ausgang Grenzeffektivstrom maximum RMS current at Rectifier output	$T_C = 80^{\circ}\text{C}$	I_{RMSmax}	36	A
Stoßstrom Grenzwert surge forward current	$t_p = 10 \text{ ms}, T_{vj} = 25^{\circ}\text{C}$	I_{FSM}	197	A
	$t_p = 10 \text{ ms}, T_{vj} = 150^{\circ}\text{C}$		158	A
Grenzlastintegral I^2t - value	$t_p = 10 \text{ ms}, T_{vj} = 25^{\circ}\text{C}$	I^2t	194	A^2s
	$t_p = 10 \text{ ms}, T_{vj} = 150^{\circ}\text{C}$		125	A^2s

Transistor Wechselrichter/ Transistor Inverter

Kollektor-Emitter-Sperrspannung collector-emitter voltage	$T_{vj} = 25^{\circ}\text{C}$	V_{CES}	600	V
Kollektor-Dauergleichstrom DC-collector current	$T_C = 65^{\circ}\text{C}$	$I_{C,nom.}$	15	A
	$T_C = 25^{\circ}\text{C}$	I_C	19	A
Periodischer Kollektor Spitzenstrom repetitive peak collector current	$t_p = 1 \text{ ms}, T_C = 65^{\circ}\text{C}$	I_{CRM}	30	A
Gesamt-Verlustleistung total power dissipation	$T_C = 25^{\circ}\text{C}$	P_{tot}	60	W
Gate-Emitter-Spitzenspannung gate-emitter peak voltage		V_{GES}	+/- 20V	V

Diode Wechselrichter/ Diode Inverter

Dauergleichstrom DC forward current		I_F	15	A
Periodischer Spitzenstrom repetitive peak forw. current	$t_p = 1 \text{ ms}$	I_{FRM}	30	A
Grenzlastintegral I^2t - value	$V_R = 0\text{V}, t_p = 10\text{ms}, T_{vj} = 125^{\circ}\text{C}$	I^2t	25	A^2s

Transistor Brems-Chopper/ Transistor Brake-Chopper

Kollektor-Emitter-Sperrspannung collector-emitter voltage	$T_{vj} = 25^{\circ}\text{C}$	V_{CES}	600	V
Kollektor-Dauergleichstrom DC-collector current	$T_C = 65^{\circ}\text{C}$	$I_{C,nom.}$	15	A
	$T_C = 25^{\circ}\text{C}$	I_C	19	A
Periodischer Kollektor Spitzenstrom repetitive peak collector current	$t_p = 1 \text{ ms}, T_C = 65^{\circ}\text{C}$	I_{CRM}	30	A
Gesamt-Verlustleistung total power dissipation	$T_C = 25^{\circ}\text{C}$	P_{tot}	60	W
Gate-Emitter-Spitzenspannung gate-emitter peak voltage		V_{GES}	+/- 20V	V

Diode Brems-Chopper/ Diode Brake-Chopper

Dauergleichstrom DC forward current		I_F	15	A
Periodischer Spitzenstrom repetitive peak forw. current	$t_p = 1 \text{ ms}$	I_{FRM}	30	A

prepared by: Thomas Passe	date of publication: 2002-02-13
approved by: Ingo Graf	revision: 5

Technische Information / Technical Information

IGBT-Module
IGBT-Modules

FP15R06KL4

eupec

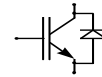

Vorläufig
Preliminary

Modul Isolation/ Module Isolation

Isolations-Prüfspannung insulation test voltage	RMS, f = 50 Hz, t = 1 min. NTC connected to Baseplate	V _{ISOL}	2,5	kV
--	--	-------------------	-----	----

Elektrische Eigenschaften / Electrical properties

Charakteristische Werte / Characteristic values

Diode Gleichrichter/ Diode Rectifier

			min.	typ.	max.	
Durchlaßspannung forward voltage	T _{vj} = 150°C, I _F = 15 A	V _F	-	1	-	V
Schleusenspannung threshold voltage	T _{vj} = 150°C	V _(TO)	-	0,71	-	V
Ersatzwiderstand slope resistance	T _{vj} = 150°C	r _T	-	18	-	mΩ
Sperrstrom reverse current	T _{vj} = 150°C, V _R = 800 V	I _R	-	5	-	mA
Modul Leitungswiderstand, Anschlüsse-Chip lead resistance, terminals-chip	T _C = 25°C	R _{AA'+CC'}	-	11	-	mΩ

Transistor Wechselrichter/ Transistor Inverter

			min.	typ.	max.	
Kollektor-Emitter Sättigungsspannung collector-emitter saturation voltage	V _{GE} = 15V, T _{vj} = 25°C, I _C = 15 A	V _{CE sat}	-	1,95	2,55	V
	V _{GE} = 15V, T _{vj} = 125°C, I _C = 15 A		-	2,2	-	V
Gate-Schwellenspannung gate threshold voltage	V _{CE} = V _{GE} , T _{vj} = 25°C, I _C = 0,4mA	V _{GE(TO)}	4,5	5,5	6,5	V
Eingangskapazität input capacitance	f = 1MHz, T _{vj} = 25°C V _{CE} = 25 V, V _{GE} = 0 V	C _{ies}	-	0,8	-	nF
Kollektor-Emitter Reststrom collector-emitter cut-off current	V _{GE} = 0V, T _{vj} = 125°C, V _{CE} = 600V	I _{CES}	-	5,0	-	mA
Gate-Emitter Reststrom gate-emitter leakage current	V _{CE} = 0V, V _{GE} = 20V, T _{vj} = 25°C	I _{GES}	-	-	400	nA
Einschaltverzögerungszeit (ind. Last) turn on delay time (inductive load)	I _C = I _{Nenn} , V _{CC} = 300 V V _{GE} = ±15V, T _{vj} = 25°C, R _G = 68 Ohm	t _{d,on}	-	37	-	ns
	V _{GE} = ±15V, T _{vj} = 125°C, R _G = 68 Ohm		-	34	-	ns
Anstiegszeit (induktive Last) rise time (inductive load)	I _C = I _{Nenn} , V _{CC} = 300 V V _{GE} = ±15V, T _{vj} = 25°C, R _G = 68 Ohm	t _r	-	37	-	ns
	V _{GE} = ±15V, T _{vj} = 125°C, R _G = 68 Ohm		-	37	-	ns
Abschaltverzögerungszeit (ind. Last) turn off delay time (inductive load)	I _C = I _{Nenn} , V _{CC} = 300 V V _{GE} = ±15V, T _{vj} = 25°C, R _G = 68 Ohm	t _{d,off}	-	216	-	ns
	V _{GE} = ±15V, T _{vj} = 125°C, R _G = 68 Ohm		-	223	-	ns
Fallzeit (induktive Last) fall time (inductive load)	I _C = I _{Nenn} , V _{CC} = 300 V V _{GE} = ±15V, T _{vj} = 25°C, R _G = 68 Ohm	t _f	-	17	-	ns
	V _{GE} = ±15V, T _{vj} = 125°C, R _G = 68 Ohm		-	26	-	ns
Einschaltverlustenergie pro Puls turn-on energy loss per pulse	I _C = I _{Nenn} , V _{CC} = 300 V V _{GE} = ±15V, T _{vj} = 125°C, R _G = 68 Ohm L _S = 80 nH	E _{on}	-	0,6	-	mWs
Abschaltverlustenergie pro Puls turn-off energy loss per pulse	I _C = I _{Nenn} , V _{CC} = 300 V V _{GE} = ±15V, T _{vj} = 125°C, R _G = 68 Ohm L _S = 80 nH	E _{off}	-	0,4	-	mWs
Kurzschlußverhalten SC Data	t _p ≤ 10µs, V _{GE} ≤ 15V, R _G = 68 Ohm T _{vj} ≤ 125°C, V _{CC} = 360 V di/dt = 1000 A/µs	I _{SC}	-	60	-	A

Technische Information / Technical Information

IGBT-Module
IGBT-Modules

FP15R06KL4

eupec

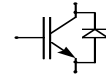

Vorläufig
Preliminary

Elektrische Eigenschaften / Electrical properties

Charakteristische Werte / Characteristic values

		min.	typ.	max.		
Modulinduktivität stray inductance module		L_{GCE}	-	-	40	nH
Modul Leitungswiderstand, Anschlüsse-Chip lead resistance, terminals-chip	$T_C = 25^\circ\text{C}$	$R_{\text{CC}'+\text{EE}'}$	-	14	-	m Ω
Diode Wechselrichter/ Diode Inverter			min.	typ.	max.	
Durchlaßspannung forward voltage	$V_{\text{GE}} = 0\text{V}, T_{\text{vj}} = 25^\circ\text{C}, I_{\text{F}} = 15\text{A}$ $V_{\text{GE}} = 0\text{V}, T_{\text{vj}} = 125^\circ\text{C}, I_{\text{F}} = 15\text{A}$	V_{F}	-	1,75 1,8	2,15 -	V V
Rückstromspitze peak reverse recovery current	$I_{\text{F}}=I_{\text{Nenn}}, -di_{\text{F}}/dt = 600\text{A/us}$ $V_{\text{GE}} = -10\text{V}, T_{\text{vj}} = 25^\circ\text{C}, V_{\text{R}} = 300\text{V}$ $V_{\text{GE}} = -10\text{V}, T_{\text{vj}} = 125^\circ\text{C}, V_{\text{R}} = 300\text{V}$	I_{RM}	-	13 14	- -	A A
Sperrverzögerungsladung recovered charge	$I_{\text{F}}=I_{\text{Nenn}}, -di_{\text{F}}/dt = 600\text{A/us}$ $V_{\text{GE}} = -10\text{V}, T_{\text{vj}} = 25^\circ\text{C}, V_{\text{R}} = 300\text{V}$ $V_{\text{GE}} = -10\text{V}, T_{\text{vj}} = 125^\circ\text{C}, V_{\text{R}} = 300\text{V}$	Q_{r}	-	0,8 1,4	- -	μAs μAs
Abschaltenergie pro Puls reverse recovery energy	$I_{\text{F}}=I_{\text{Nenn}}, -di_{\text{F}}/dt = 600\text{A/us}$ $V_{\text{GE}} = -10\text{V}, T_{\text{vj}} = 25^\circ\text{C}, V_{\text{R}} = 300\text{V}$ $V_{\text{GE}} = -10\text{V}, T_{\text{vj}} = 125^\circ\text{C}, V_{\text{R}} = 300\text{V}$	E_{rec}	-	0,14 0,24	- -	mWs mWs
Transistor Brems-Chopper/ Transistor Brake-Chopper			min.	typ.	max.	
Kollektor-Emitter Sättigungsspannung collector-emitter saturation voltage	$V_{\text{GE}} = 15\text{V}, T_{\text{vj}} = 25^\circ\text{C}, I_{\text{C}} = 15,0\text{A}$ $V_{\text{GE}} = 15\text{V}, T_{\text{vj}} = 125^\circ\text{C}, I_{\text{C}} = 15,0\text{A}$	$V_{\text{CE sat}}$	-	1,95 2,2	2,55 -	V V
Gate-Schwellenspannung gate threshold voltage	$V_{\text{CE}} = V_{\text{GE}}, T_{\text{vj}} = 25^\circ\text{C}, I_{\text{C}} = 0,4\text{mA}$	$V_{\text{GE(To)}}$	4,5	5,5	6,5	V
Eingangskapazität input capacitance	$f = 1\text{MHz}, T_{\text{vj}} = 25^\circ\text{C}$ $V_{\text{CE}} = 25\text{V}, V_{\text{GE}} = 0\text{V}$	C_{ies}	-	0,8	-	nF
Kollektor-Emitter Reststrom collector-emitter cut-off current	$V_{\text{GE}} = 0\text{V}, T_{\text{vj}} = 125^\circ\text{C}, V_{\text{CE}} = 600\text{V}$		-	5,0	-	mA
Gate-Emitter Reststrom gate-emitter leakage current	$V_{\text{CE}} = 0\text{V}, V_{\text{GE}} = 20\text{V}, T_{\text{vj}} = 25^\circ\text{C}$	I_{GES}	-	-	400	nA
Diode Brems-Chopper/ Diode Brake-Chopper			min.	typ.	max.	
Durchlaßspannung forward voltage	$T_{\text{vj}} = 25^\circ\text{C}, I_{\text{F}} = 15\text{A}$ $T_{\text{vj}} = 125^\circ\text{C}, I_{\text{F}} = 15\text{A}$	V_{F}	-	2,15 2,25	2,6 -	V V
NTC-Widerstand/ NTC-Thermistor			min.	typ.	max.	
Nennwiderstand rated resistance	$T_C = 25^\circ\text{C}$	R_{25}	-	5	-	k Ω
Abweichung von R_{100} deviation of R_{100}	$T_C = 100^\circ\text{C}, R_{100} = 493\ \Omega$	$\Delta R/R$	-5		5	%
Verlustleistung power dissipation	$T_C = 25^\circ\text{C}$	P_{25}			20	mW
B-Wert B-value	$R_2 = R_1 \exp [B(1/T_2 - 1/T_1)]$	$B_{25/50}$		3375		K

Technische Information / Technical Information

IGBT-Module
IGBT-Modules

FP15R06KL4

eupec

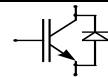

**Vorläufig
Preliminary**

Thermische Eigenschaften / Thermal properties

				min.	typ.	max.	
Innerer Wärmewiderstand thermal resistance, junction to heatsink	Gleichr. Diode/ Rectif. Diode	$\lambda_{\text{Paste}}=1\text{W/m}^2\text{K}$	R_{thJH}	-	2,6	-	K/W
	Trans. Wechr./ Trans. Inverter	$\lambda_{\text{grease}}=1\text{W/m}^2\text{K}$		-	2,4	-	K/W
	Diode Wechr./ Diode Inverter			-	4,0	-	K/W
	Trans. Bremse/ Trans. Brake			-	2,4	-	K/W
	Diode Bremse/ Diode Brake			-	4,3	-	K/W
Innerer Wärmewiderstand thermal resistance, junction to case	Gleichr. Diode/ Rectif. Diode		R_{thJC}	-	-	2,4	K/W
	Trans. Wechr./ Trans. Inverter			-	-	2	K/W
	Diode Wechr./ Diode Inverter			-	-	2,9	K/W
	Trans. Bremse/ Trans. Brake			-	-	2	K/W
	Diode Bremse/ Diode Brake			-	-	3,1	K/W
Übergangs-Wärmewiderstand thermal resistance, case to heatsink	Gleichr. Diode/ Rectif. Diode	$\lambda_{\text{Paste}}=1\text{W/m}^2\text{K}$	R_{thCH}	-	0,4	-	K/W
	Trans. Wechr./ Trans. Inverter	$\lambda_{\text{grease}}=1\text{W/m}^2\text{K}$		-	0,6	-	K/W
	Diode Wechr./ Diode Inverter			-	1,4	-	K/W
	Trans. Bremse/ Trans. Brake			-	0,6	-	K/W
	Diode Bremse/ Diode Brake			-	1,5	-	K/W
Höchstzulässige Sperrschichttemperatur maximum junction temperature			T_{vj}	-	-	150	°C
Betriebstemperatur operation temperature			T_{op}	-40	-	125	°C
Lagertemperatur storage temperature			T_{stg}	-40	-	125	°C

Mechanische Eigenschaften / Mechanical properties

Innere Isolation internal insulation				Al_2O_3	
CTI comperative tracking index				225	
Anpreßkraft f. mech. Befestigung pro Feder mounting force per clamp		F		40...80	N
Gewicht weight		G		36	g
Kontakt - Kühlkörper terminal to heatsink	Kriechstrecke creeping distance			13,5	mm
	Luftstrecke clearance			12	mm
Terminal - Terminal terminal to terminal	Kriechstrecke creeping distance			7,5	mm
	Luftstrecke clearance			7,5	mm

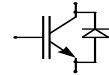

Vorläufig
Preliminary

Ausgangskennlinienfeld Wechselr. (typisch) $I_C = f(V_{CE})$
Output characteristic Inverter (typical) $V_{GE} = 15\text{ V}$

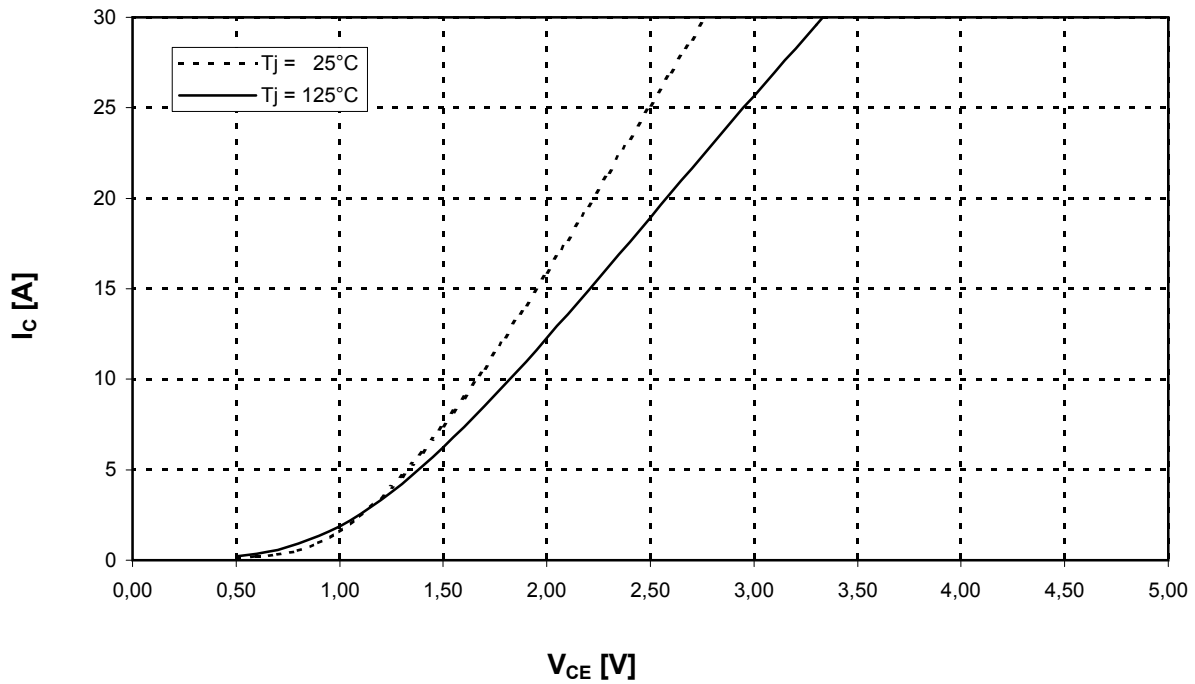

Ausgangskennlinienfeld Wechselr. (typisch) $I_C = f(V_{CE})$
Output characteristic Inverter (typical) $T_{vj} = 125^\circ\text{C}$

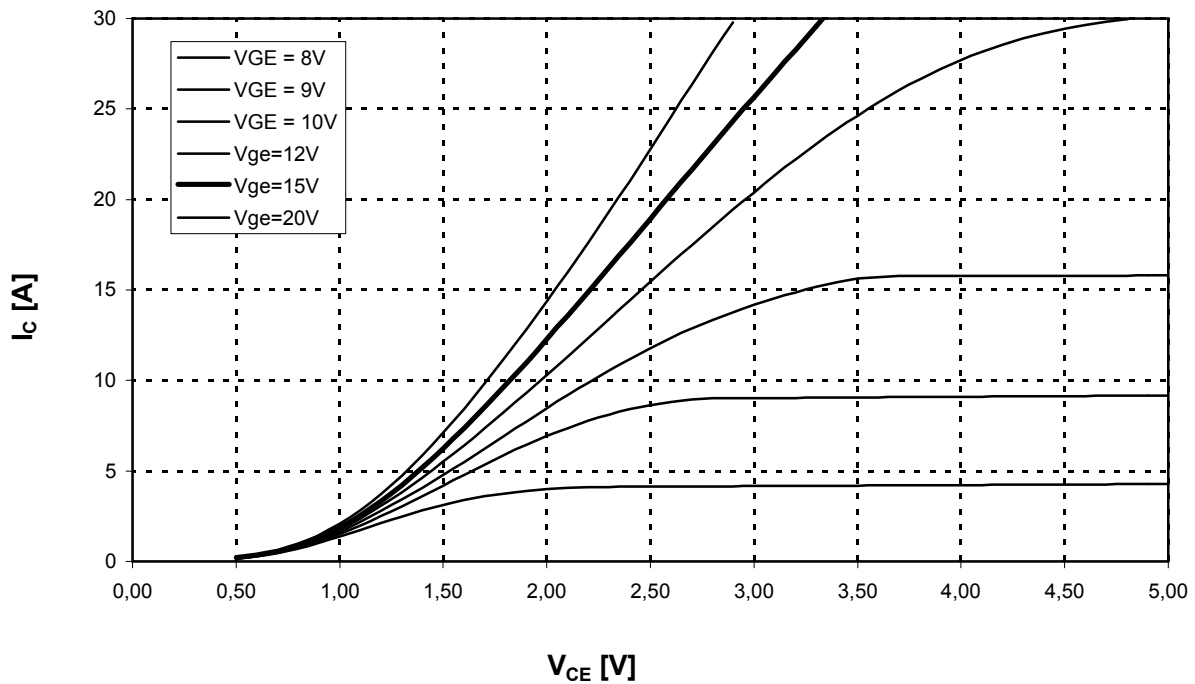

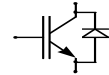

Vorläufig
Preliminary

Übertragungscharakteristik Wechselr. (typisch)

$I_C = f(V_{GE})$

Transfer characteristic Inverter (typical)

$V_{CE} = 20\text{ V}$

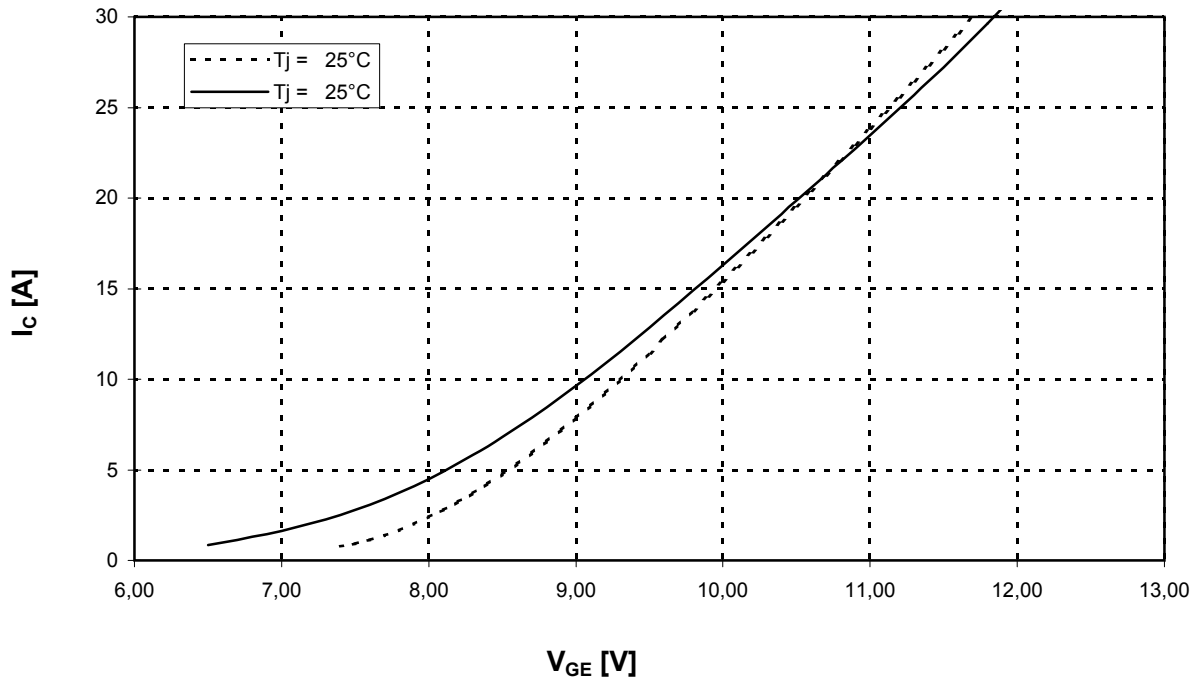

Durchlaßkennlinie der Freilaufdiode Wechselr. (typisch)

$I_F = f(V_F)$

Forward characteristic of FWD Inverter (typical)

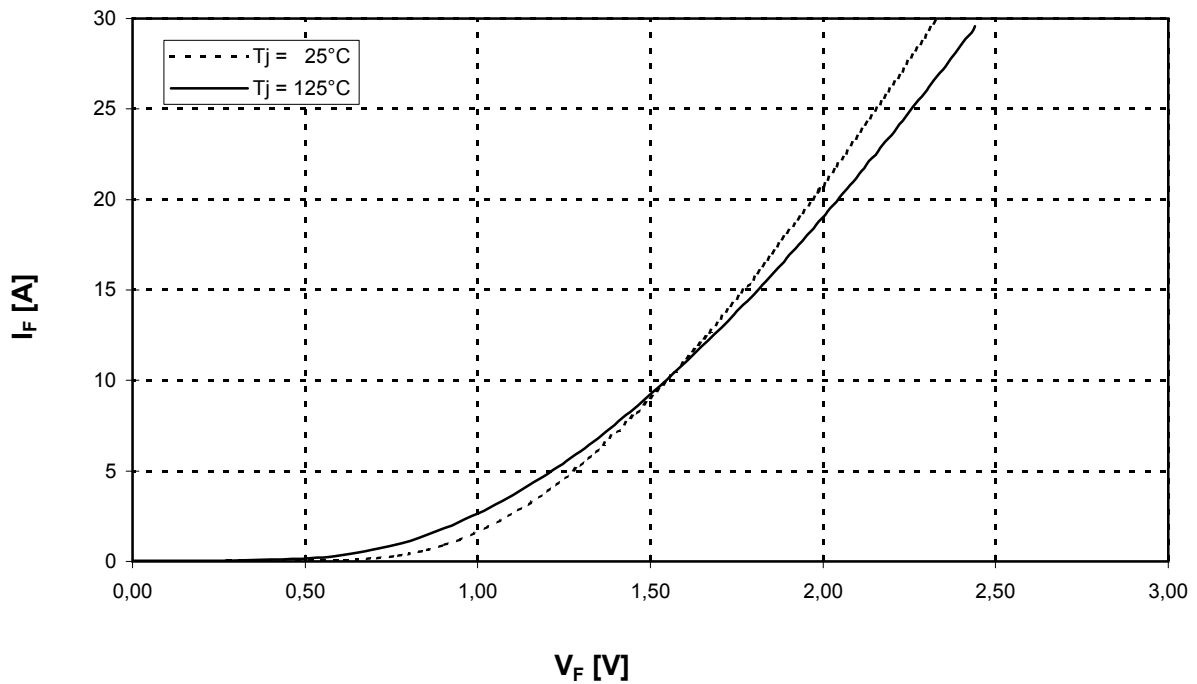

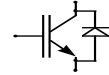

Vorläufig
Preliminary

Schaltverluste Wechselr. (typisch) $E_{on} = f(I_c), E_{off} = f(I_c), E_{rec} = f(I_c)$ $V_{CC} = 300\text{ V}$
 Switching losses Inverter (typical) $T_j = 125^\circ\text{C}, V_{GE} = \pm 15\text{ V}, R_{Gon} = R_{Goff} = 68\text{ Ohm}$

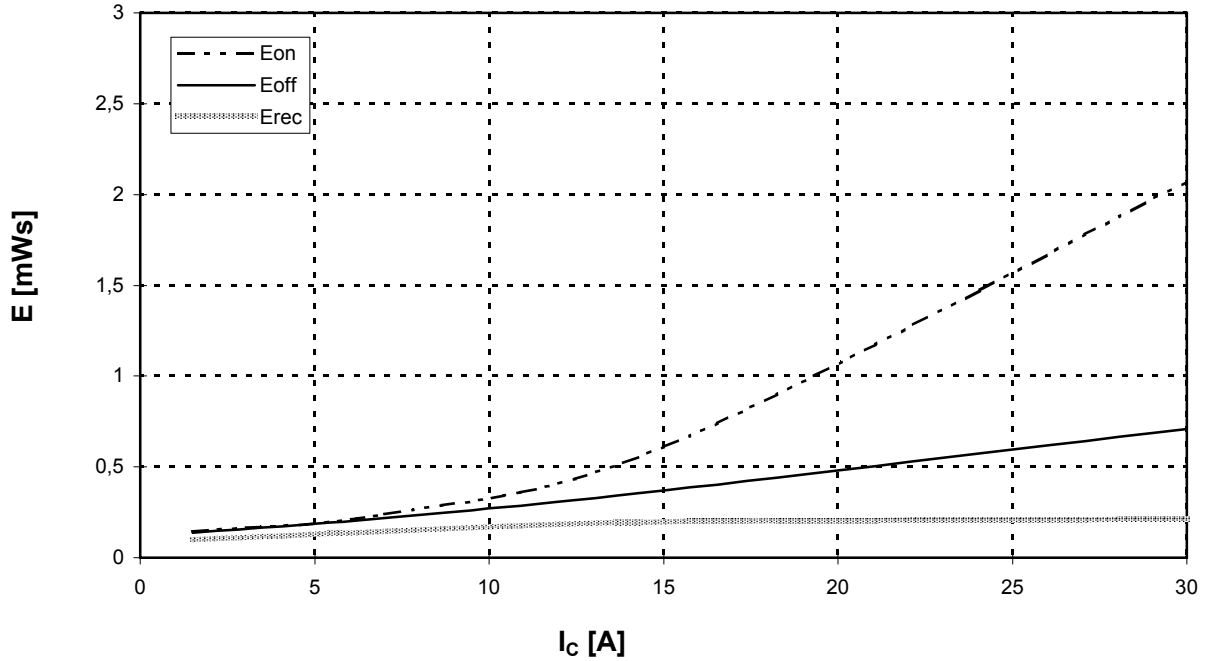

Schaltverluste Wechselr. (typisch) $E_{on} = f(R_G), E_{off} = f(R_G), E_{rec} = f(R_G)$
 Switching losses Inverter (typical) $T_j = 125^\circ\text{C}, V_{GE} = +15\text{ V}, I_c = I_{nenn}, V_{CC} = 300\text{ V}$

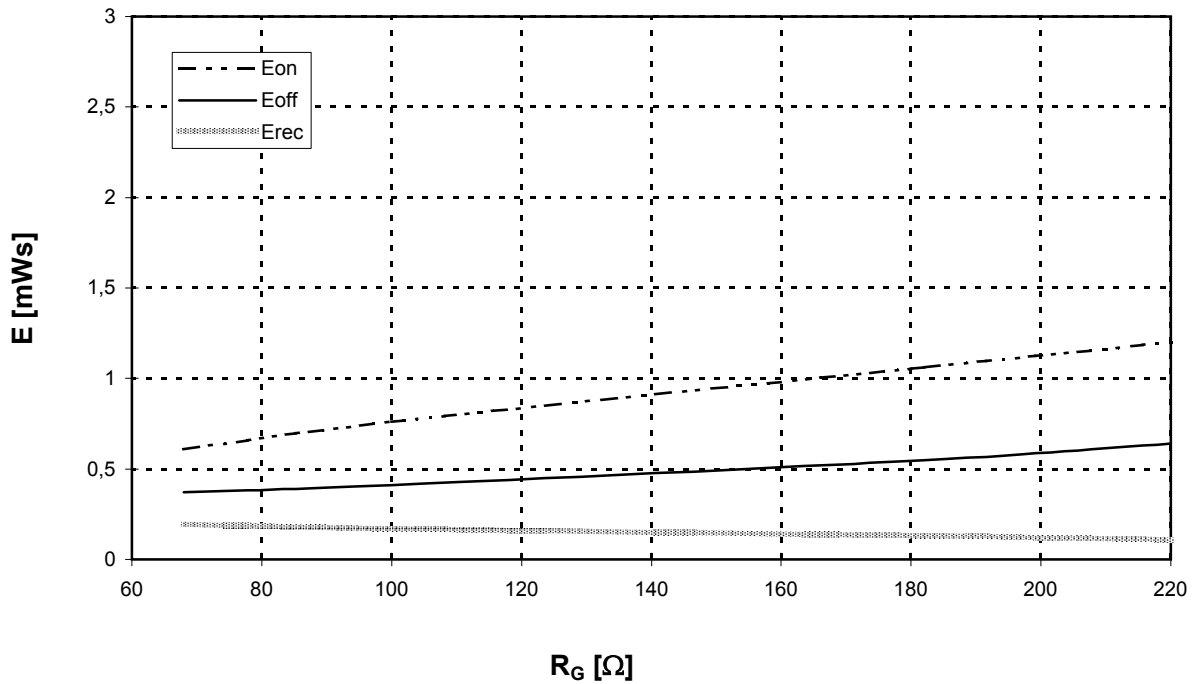

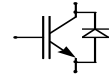

Vorläufig
Preliminary

Transienter Wärmewiderstand Wechsler. $Z_{thJH} = f(t)$
Transient thermal impedance Inverter

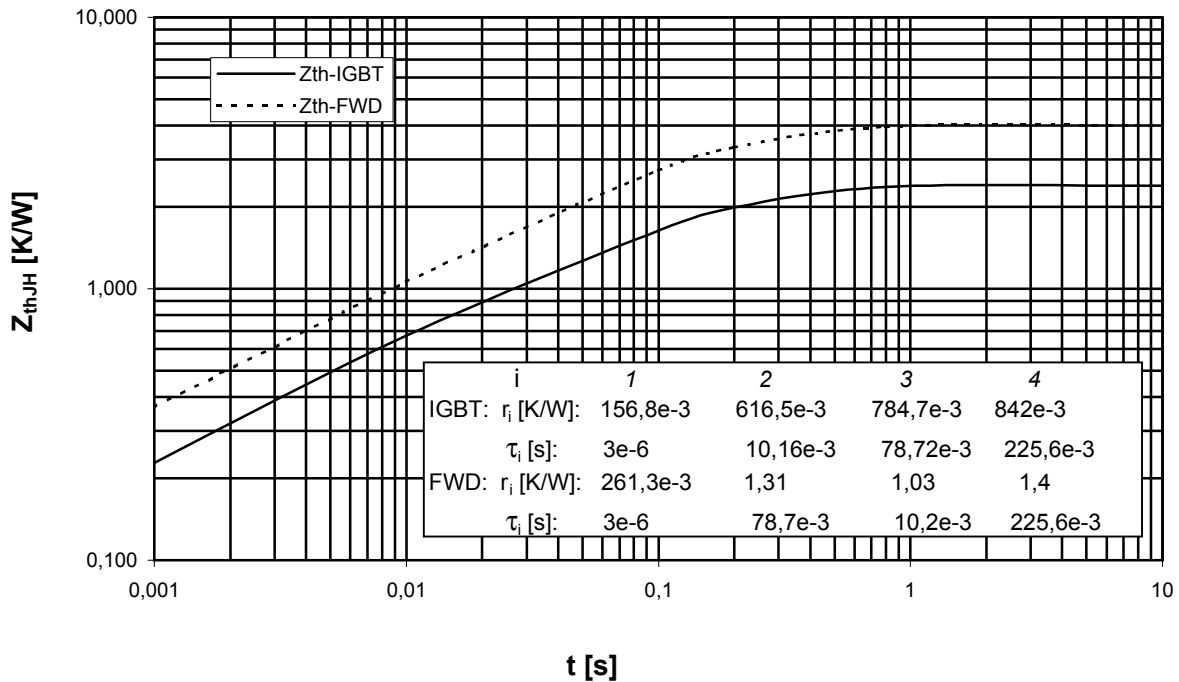

Sicherer Arbeitsbereich Wechsler. (RBSOA) $I_C = f(V_{CE})$
Reverse bias safe operating area Inverter (RBSOA) $T_{vj} = 125^\circ\text{C}$, $V_{GE} = \pm 15\text{V}$, $R_G = 68 \text{ Ohm}$

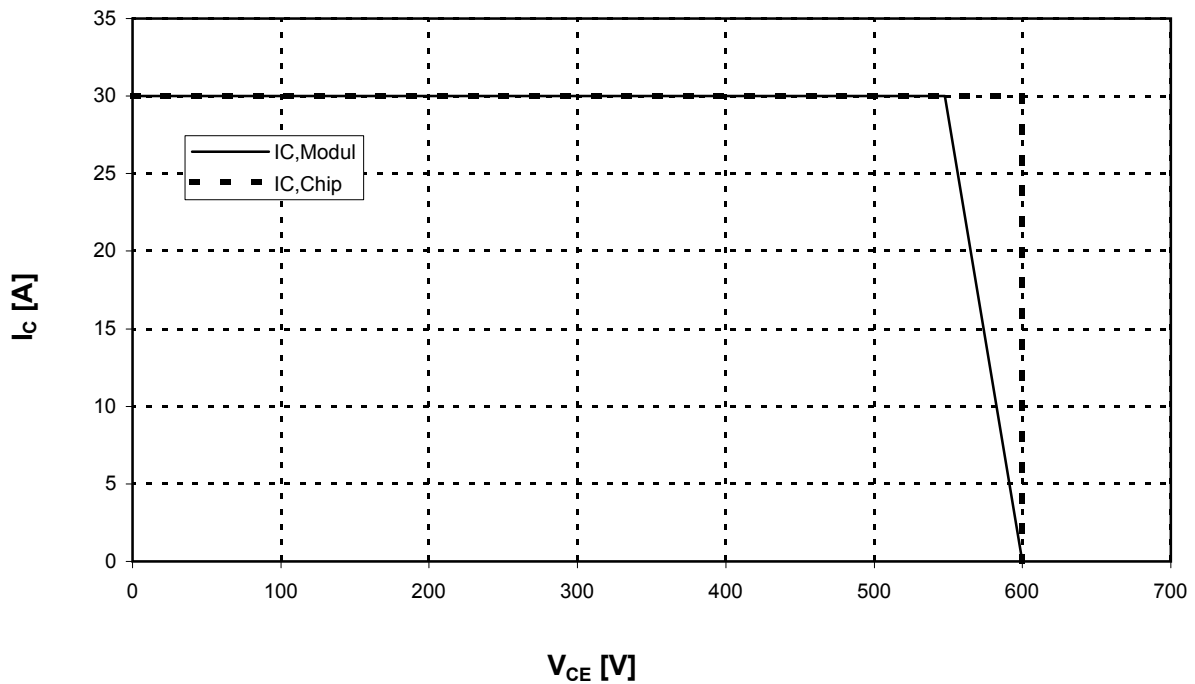

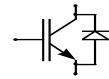

Vorläufig
Preliminary

Ausgangskennlinienfeld Brems-Chopper-IGBT (typisch)

$I_C = f(V_{CE})$

Output characteristic brake-chopper-IGBT (typical)

$V_{GE} = 15\text{ V}$

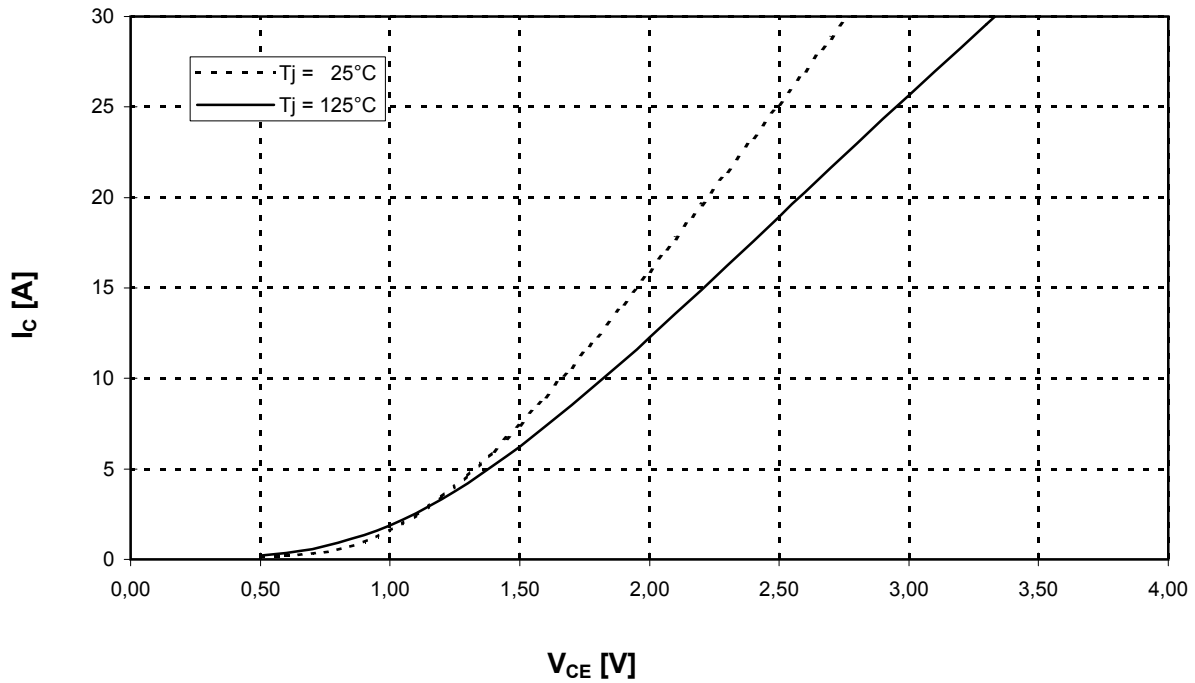

Durchlaßkennlinie der Brems-Chopper-Diode (typisch) $I_F = f(V_F)$

Forward characteristic of brake-chopper-FWD (typical)

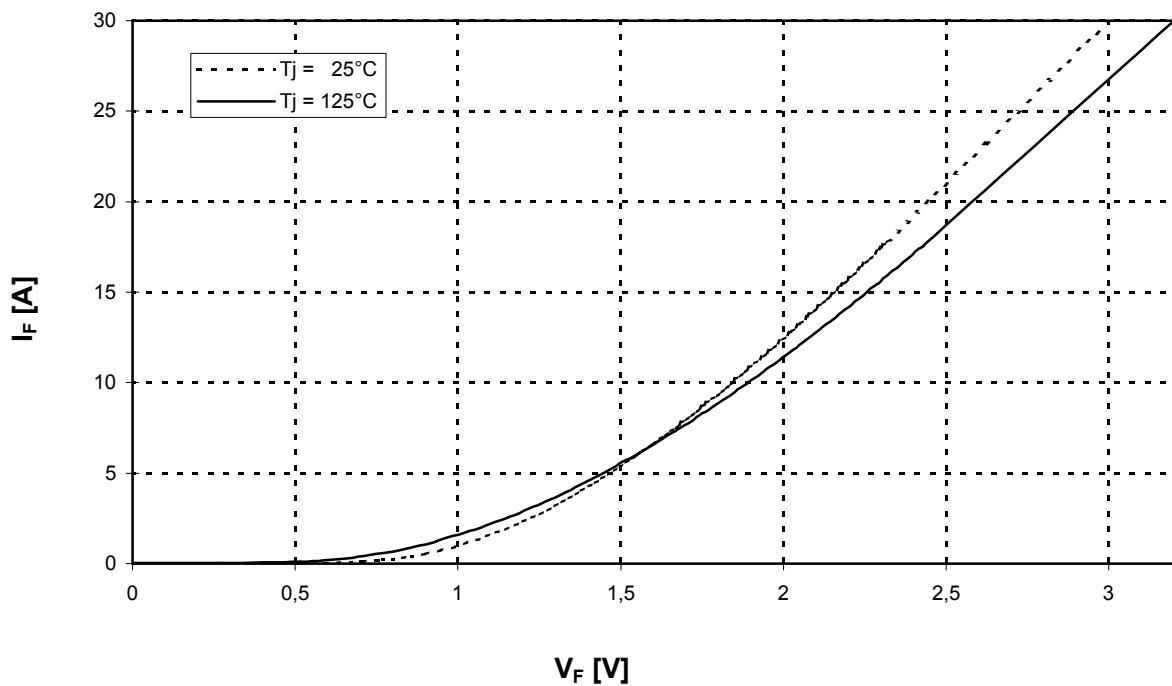

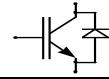

Vorläufig
Preliminary

Durchlaßkennlinie der Gleichrichterdiode (typisch) $I_F = f(V_F)$
Forward characteristic of Rectifier Diode (typical)

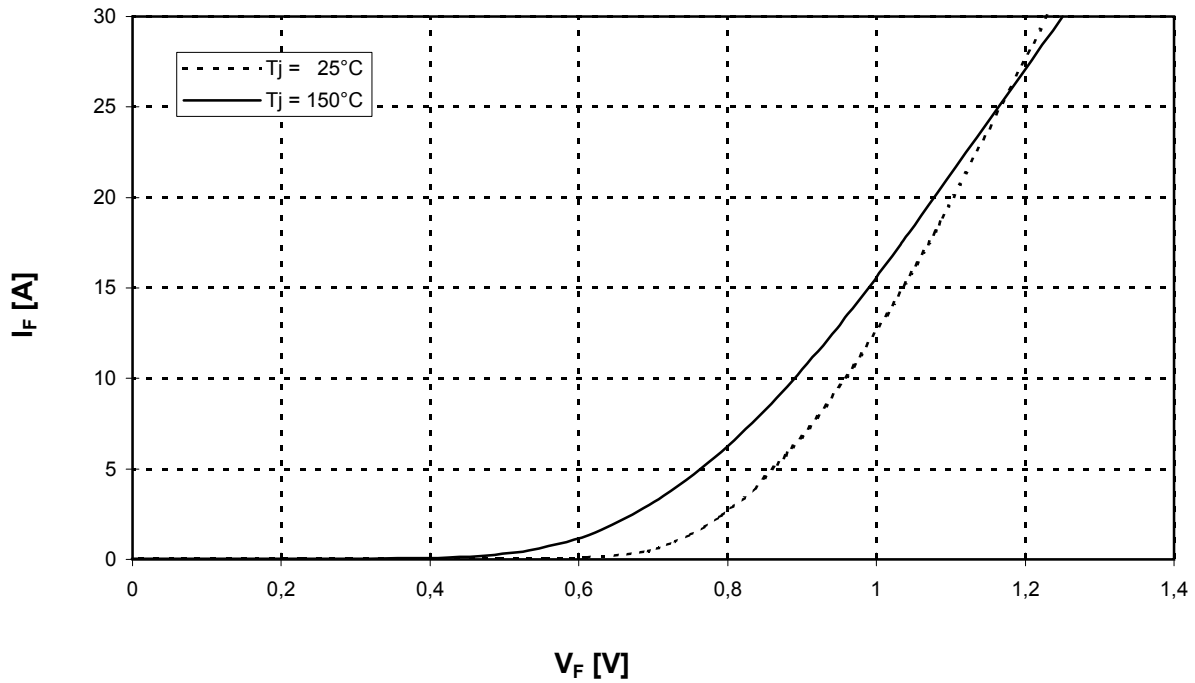

NTC- Temperaturkennlinie (typisch) $R = f(T)$
NTC- temperature characteristic (typical)

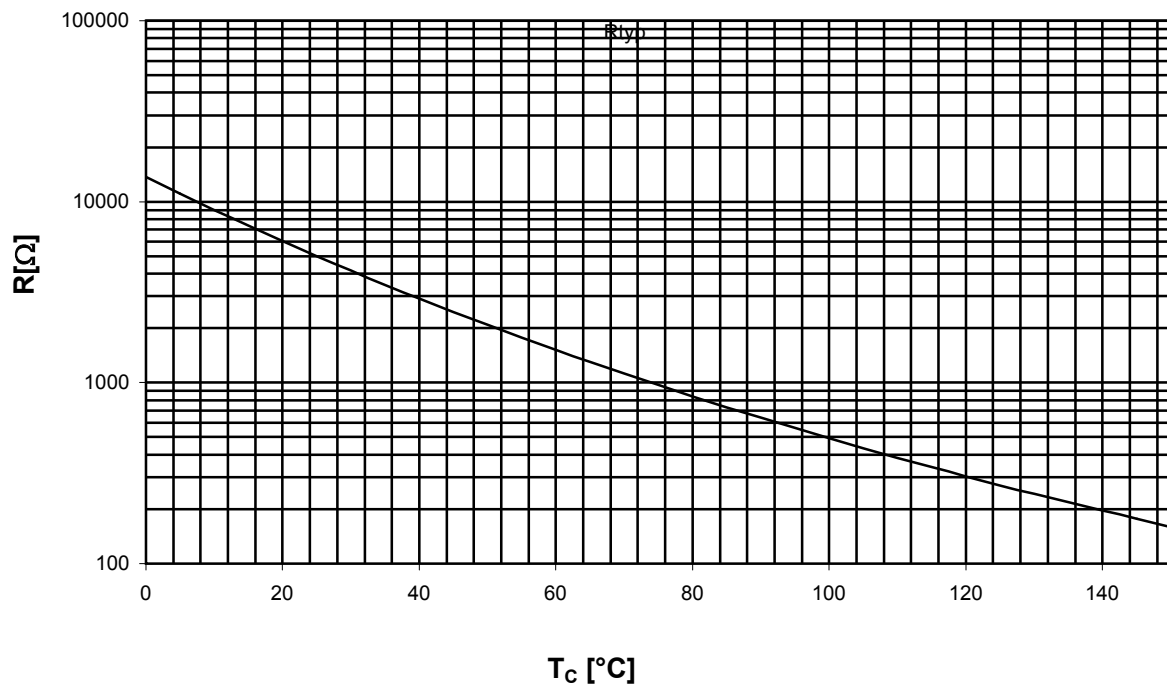

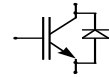

Vorläufig
Preliminary

Schaltplan/ Circuit diagram

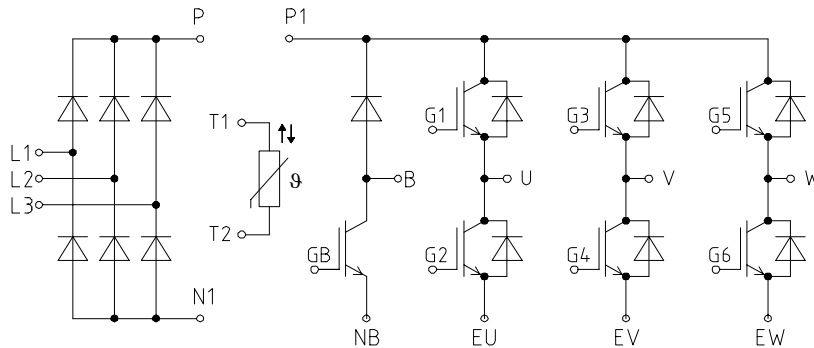

Gehäuseabmessungen/ Package outlines

Modul only designed for mounting on PCB's with 1.6 ±0.2 mm thickness

Pinpositions with tolerance $\pm \phi 0.4$

Bohrplan /
drilling layout

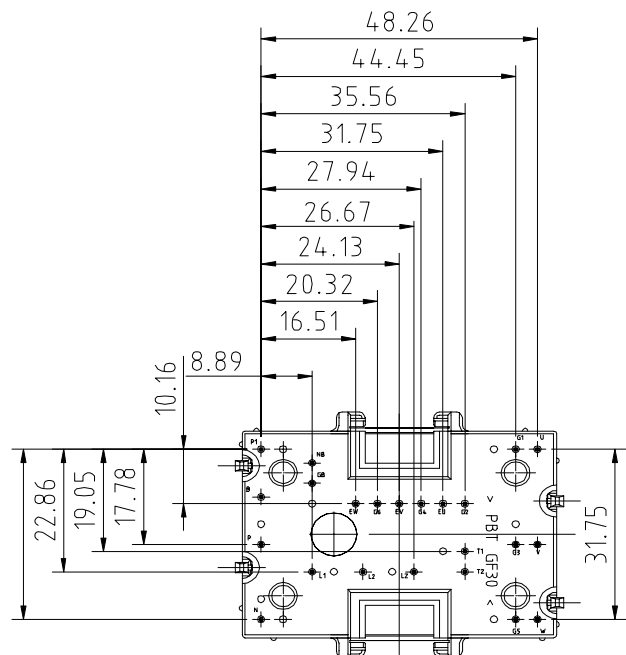
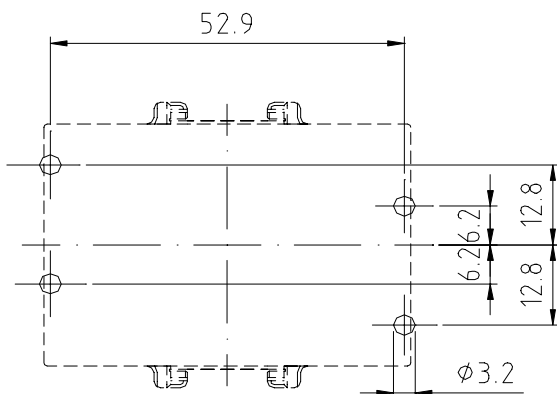

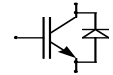

Gehäuseabmessungen Forts. / Package outlines contd.

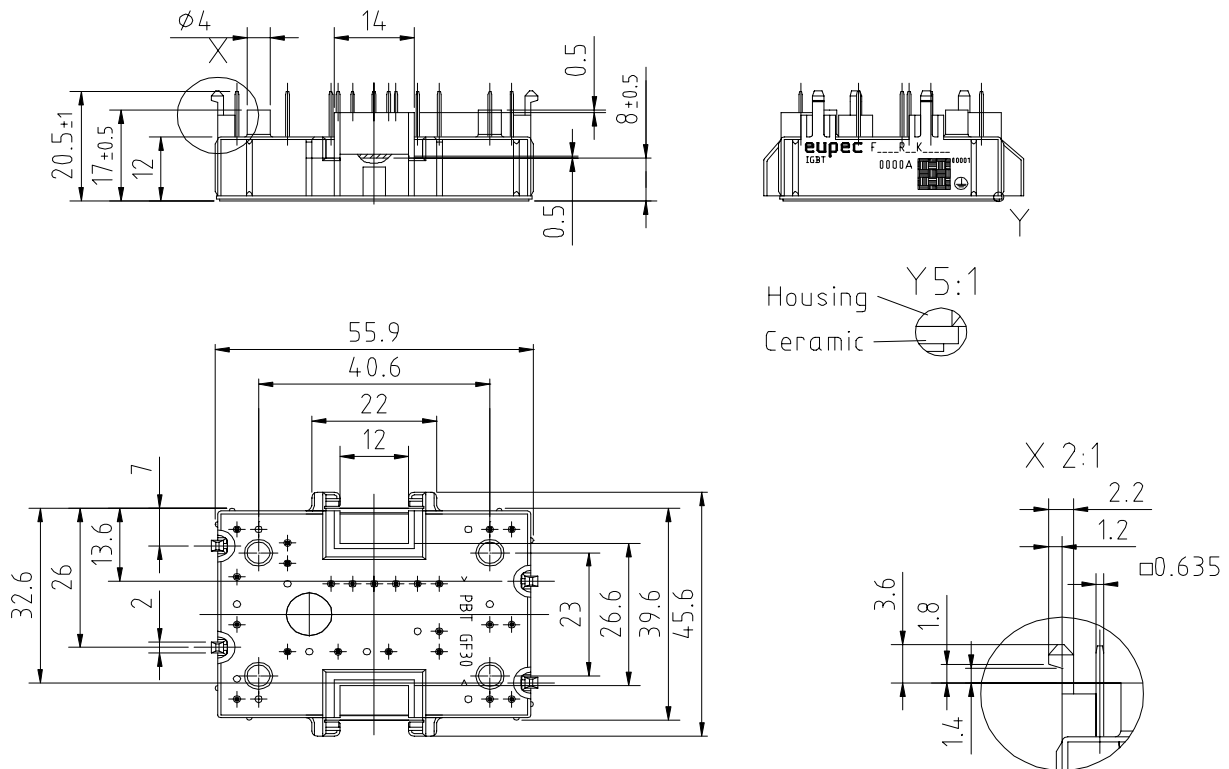

Mit dieser technischen Information werden Halbleiterbauelemente spezifiziert, jedoch keine Eigenschaften zugesichert. Diese gilt in Verbindung mit den zugehörigen Technischen Erläuterungen.

This technical information specifies semiconductor devices but promises no characteristics. It is valid in combination with the belonging technical note:

This datasheet has been downloaded from:

www.DatasheetCatalog.com

Datasheets for electronic components.